

Article 1: Base Zones

Division 4: Residential Base Zones

(Added 12-9-1997 by O-18451 N.S.; effective 1-1-2000.)

§131.0401 Purpose of Residential Zones

The purpose of the residential zones is to provide for areas of residential *development* at various specified densities throughout the City. The residential zones are intended to accommodate a variety of housing types and to encourage the provision of housing for all citizens of San Diego. It is also intended that the residential zones reflect desired *development* patterns in existing neighborhoods while accommodating the need for future growth.

(Added 12-9-1997 by O-18451 N.S.; effective 1-1-2000.)

§131.0402 Purpose of the RE (Residential--Estate) Zones

- (a) The purpose of the RE zones is to provide for *single dwelling units* on large *lots* with some accessory agricultural uses. It is intended that this zone be applied to areas that are rural in character, where the retention of low *density* residential *development* is desired.
- (b) The RE zones are differentiated based upon applicable development regulations as follows:
 - RE-1-1 requires *development* on minimum 10-acre *lots*
 - RE-1-2 requires *development* on minimum 5-acre *lots*
 - RE-1-3 requires *development* on minimum 1-acre *lots*

(Added 12-9-1997 by O-18451 N.S.; effective 1-1-2000.)

§131.0403 Purpose of the RS (Residential--Single Unit) Zones

- (a) The purpose of the RS zones is to provide appropriate regulations for the *development* of *single dwelling units* that accommodate a variety of *lot* sizes and residential dwelling types and which promote neighborhood quality, character, and livability. It is intended that these zones provide for flexibility in development regulations that allow reasonable use of property while minimizing adverse impacts to adjacent properties.

(b) The RS zones are differentiated based on the minimum *lot* size and whether the *premises* is located in an *Urbanized Community* or a *Planned Urbanized Community* or *Proposition A Lands*, as follows:

(1) *Urbanized Communities*

- RS-1-1 requires minimum 40,000-square-foot *lots*
- RS-1-2 requires minimum 20,000-square-foot *lots*
- RS-1-3 requires minimum 15,000-square-foot *lots*
- RS-1-4 requires minimum 10,000-square-foot *lots*
- RS-1-5 requires minimum 8,000-square-foot *lots*
- RS-1-6 requires minimum 6,000-square-foot *lots*
- RS-1-7 requires minimum 5,000-square-foot *lots*

(2) *Planned Urbanized Communities* or *Proposition A Lands*

- RS-1-8 requires minimum 40,000-square-foot *lots*
- RS-1-9 requires minimum 20,000-square-foot *lots*
- RS-1-10 requires minimum 15,000-square-foot *lots*
- RS-1-11 requires minimum 10,000-square-foot *lots*
- RS-1-12 requires minimum 8,000-square-foot *lots*
- RS-1-13 requires minimum 6,000-square-foot *lots*
- RS-1-14 requires minimum 5,000-square-foot *lots*

(Added 12-9-1997 by O-18451 N.S.; amended 10-18-1999 by O-18691 N.S.; effective 1-1-2000.)

(Amended 4-8-2008 by O-19734 N.S; effective 5-8-2008.)

§131.0404 Purpose of the RX (Residential--Small Lot) Zones

- (a) The purpose of the RX zones is to provide for both attached and detached *single dwelling units* on smaller *lots* than are required in the RS zones. It is intended that these zones provide an alternative to *multiple dwelling unit developments* where *single dwelling unit developments* could be developed at similar densities. The RX zone provides for a wide variety of residential *development patterns*.
- (b) The RX zones are differentiated based on the minimum *lot* size as follows:
- RX-1-1 requires minimum 4,000-square-foot *lots*
 - RX-1-2 requires minimum 3,000-square-foot *lots*

(Added 12-9-1997 by O-18451 N.S.; effective 1-1-2000.)

§131.0405 Purpose of the RT (Residential--Townhouse) Zones

- (a) The purpose of the RT zones is to provide for attached, single-dwelling unit residential *development* on small *lots* with *alley* access. It is intended that these zones provide for more urbanized, single-unit living at densities that are historically more typical of multiple-unit zones. The RT zones provide transition opportunities between single-unit neighborhoods and higher *density* multiple-unit neighborhoods and in some instances may replace multiple-unit zones at similar densities. The RT zones are intended to be applied on subdivided blocks with *alleys* that are within or close to highly urbanized areas, *transit areas*, and redevelopment areas.
- (b) The RT zones are differentiated based on the minimum *lot* size as follows:
- RT-1-1 requires minimum 3,500-square-foot *lots*
 - RT-1-2 requires minimum 3,000-square-foot *lots*
 - RT-1-3 requires minimum 2,500-square-foot *lots*
 - RT-1-4 requires minimum 2,200-square-foot *lots*
 - RT-1-5 requires minimum 1,600-square-foot *lots*

(Added 12-9-1997 by O-18451 N.S.; effective 1-1-2000.)

(Amended 7-10-2015 by O-20512 N.S.; effective 8-9-2015.)

§131.0406 Purpose of the RM (Residential--Multiple Unit) Zones

- (a) The purpose of the RM zones is to provide for *multiple dwelling unit development* at varying densities. The RM zones individually accommodate *developments* with similar densities and characteristics. Each of the RM zones is intended to establish *development* criteria that consolidates common development regulations, accommodates specific dwelling types, and responds to locational issues regarding adjacent land uses.

- (b) The RM zones are differentiated based on the uses allowed and the permitted *density* as follows:
 - (1) The following zones permit lower *density multiple dwelling units* with some characteristics of *single dwelling units*:
 - RM-1-1 permits a maximum *density* of 1 dwelling unit for each 3,000 square feet of *lot area*
 - RM-1-2 permits a maximum *density* of 1 dwelling unit for each 2,500 square feet of *lot area*
 - RM-1-3 permits a maximum *density* of 1 dwelling unit for each 2,000 square feet of *lot area*

 - (2) The following zones permit medium *density multiple dwelling units*:
 - RM-2-4 permits a maximum *density* of 1 dwelling unit for each 1,750 square feet of *lot area*
 - RM-2-5 permits a maximum *density* of 1 dwelling unit for each 1,500 square feet of *lot area*
 - RM-2-6 permits a maximum *density* of 1 dwelling unit for each 1,250 square feet of *lot area*

 - (3) The following zones permit medium *density multiple dwelling units* with limited commercial uses:
 - RM-3-7 permits a maximum *density* of 1 dwelling unit for each 1,000 square feet of *lot area*
 - RM-3-8 permits a maximum *density* of 1 dwelling unit for each 800 square feet of *lot area*
 - RM-3-9 permits a maximum *density* of 1 dwelling unit for each 600 square feet of *lot area*

- (4) The following zones permit urbanized, high *density multiple dwelling units* with limited commercial uses:
 - RM-4-10 permits a maximum *density* of 1 dwelling unit for each 400 square feet of *lot* area
 - RM-4-11 permits a maximum *density* of 1 dwelling unit for each 200 square feet of lot area
- (5) RM-5-12 permits visitor accommodations or medium *density multiple dwelling units* at a maximum *density* of 1 dwelling unit for each 1,000 square feet of lot area.

(Added 12-9-1997 by O-18451 N.S.; effective 1-1-2000.)

§131.0415 Where Residential Zones Apply

On the effective date of Ordinance O-18691, all residential zones that were established in Municipal Code Chapter 10, Article 1, Division 4 were amended and replaced with the base zones established in this division.

(Added 12-9-1997 by O-18451 N.S.; effective 1-1-2000.)

(Amended 11-13-2008 by O-19801 N.S.; effective 12-13-2008.)

§131.0420 Use Regulations of Residential Zones

The regulations of Section 131.0422 apply in the residential zones where indicated in Table 131-04B.

- (a) The uses permitted in any residential zone may be further limited by the following:
 - (1) Section 131.0423 (Additional Use Regulations of Residential Zones);
 - (2) Use limitations applicable to the Airport Land Use Compatibility Overlay Zone (Chapter 13, Article 2, Division 15);
 - (3) The presence of *environmentally sensitive lands*, pursuant to Chapter 14, Article 3, Division 1 (Environmentally Sensitive Lands Regulations); or
 - (4) Any other applicable provision of the San Diego Municipal Code.

- (b) Within the residential zones, no *structure* or improvement, or portion thereof, shall be constructed, established, or altered, nor shall any *premises* be used or maintained except for one or more of the purposes or activities listed in Table 131-04B. It is unlawful to establish, maintain, or use any *premises* for any purpose or activity not listed in this section or Section 131.0422.
- (c) All uses or activities permitted in the residential zones shall be conducted entirely within an enclosed building unless the use or activity is traditionally conducted outdoors.
- (d) *Accessory uses* in the residential zones may be permitted in accordance with Section 131.0125.
- (e) Temporary uses may be permitted in the residential zones for a limited period of time with a Temporary Use Permit in accordance with Chapter 12, Article 3, Division 4.
- (f) For any use that cannot be readily classified, the City Manager shall determine the appropriate use category and use subcategory pursuant to Section 131.0110.

(Added 12-9-1997 by O-18451 N.S)

(Amended 10-18-1999 by O-18691 N.S.; effective 1-1-2000.)

(Amended 10-25-2011 by O-20047 N.S.; effective 1-1-2012.)

(Amended 6-18-2013 by O-20261 N.S.; effective 7-19-2013.)

§131.0422 Use Regulations Table for Residential Zones

The uses allowed in the residential zones are shown in the Table 131-04B.

Legend for Table 131-04B

Symbol In Table 131-04B	Description Of Symbol
P	Use or use category is permitted. Regulations pertaining to a specific use may be referenced.
L	Use is permitted with limitations, which may include location limitations or the requirement for a use or <i>development permit</i> . Regulations are located in Chapter 14, Article 1 (Separately Regulated Use Regulations).
N	Neighborhood Use Permit Required. Regulations are located in Chapter 14, Article 1 (Separately Regulated Use Regulations).
C	Conditional Use Permit Required. Regulations are located in Chapter 14, Article 1 (Separately Regulated Use Regulations).
-	Use or use category is not permitted.

**Table 131-04B
Use Regulations Table for Residential Zones**

Use Categories/ Subcategories [See Section 131.0112 for an explanation and descriptions of the Use Categories, Subcategories, and Separately Regulated Uses]	Zone Designator	Zones																						
	1st & 2nd >>	RE-	RS-														RX-		RT-					
	3rd >>	1-	1-														1-		1-					
	4th >>	1	2	3	1	2	3	4	5	6	7	8	9	10	11	12	13	14	1	2	1	2	3	4
Open Space																								
Active Recreation	P	P														P		P						
Passive Recreation	P	P														P		P						
Natural Resources Preservation	P	P														P		P						
Park Maintenance Facilities	-	-														-		-						
Agriculture																								
Agricultural Processing	-	-														-		-						
Aquaculture Facilities	-	-														-		-						
Dairies	-	-														-		-						
Horticulture Nurseries & Greenhouses	-	-														-		-						
Raising & Harvesting of Crops	P ⁽³⁾	-														-		-						
Raising, Maintaining & Keeping of Animals	P ⁽³⁾⁽⁸⁾	-														-		-						
Separately Regulated Agriculture Uses																								
Agricultural Equipment Repair Shops	-	-														-		-						
Commercial Stables	-	-														-		-						
Community Gardens	L	L														L		L						
Equestrian Show & Exhibition Facilities	-	-														-		-						
Open Air Markets for the Sale of Agriculture-Related Products & Flowers	-	-														-		-						
Residential																								

Use Categories/ Subcategories [See Section 131.0112 for an explanation and descriptions of the Use Categories, Subcategories, and Separately Regulated Uses]	Zone Designator	Zones																						
	1st & 2nd >>	RE-	RS-												RX-		RT-							
	3rd >>	1-	1-												1-		1-							
	4th >>	1	2	3	1	2	3	4	5	6	7	8	9	10	11	12	13	14	1	2	1	2	3	4
Mobilehome Parks	-	P ⁽¹⁾												P ⁽¹⁾		-								
Multiple Dwelling Units	-	-																						
Rooming House [See Section 131.0112(a)(3)(A)]	-	-																						
Shopkeeper Units	-	-																						
Single Dwelling Units	P ⁽¹²⁾	P ⁽⁹⁾⁽¹²⁾												P ⁽⁹⁾⁽¹²⁾		P ⁽⁹⁾								
Separately Regulated Residential Uses																								
<i>Boarder & Lodger Accommodations</i>	L	L												L		L								
Companion Units	L	L												L		L								
Employee Housing:																								
6 or Fewer Employees	-	-												-		-								
12 or Fewer Employees	-	-												-		-								
Greater than 12 Employees	-	-												-		-								
Fraternities, Sororities and Student Dormitories	-	-												-		-								
Garage, Yard, & Estate Sales	L	L												L		L								
Guest Quarters	L	L												L		-								
Home Occupations	L	L												L		L								
Housing for Senior Citizens	C	C												C		C								
Live/Work Quarters	-	-												-		-								
Residential Care Facilities:																								
6 or Fewer Persons	P	P												P		P								
7 or More Persons	C	C												C		C								
Transitional Housing:																								

Use Categories/ Subcategories [See Section 131.0112 for an explanation and descriptions of the Use Categories, Subcategories, and Separately Regulated Uses]	Zone Designator	Zones																						
	1st & 2nd >>	RE-	RS-														RX-		RT-					
	3rd >>	1-	1-														1-		1-					
	4th >>	1	2	3	1	2	3	4	5	6	7	8	9	10	11	12	13	14	1	2	1	2	3	4
6 or Fewer Persons	P	P														P		P						
7 or More Persons	C	C														C		C						
Watchkeeper Quarters	-	-														-		-						
Institutional																								
Separately Regulated Institutional Uses																								
Airports	-	-														-		-						
Botanical Gardens & Arboretums	C	C														C		C						
Cemeteries, Mausoleums, Crematories	-	-														-		-						
Correctional Placement Centers	-	-														-		-						
Educational Facilities:																								
Kindergarten through Grade 12	C	C														C		C						
Colleges / Universities	C	C														C		C						
Vocational / Trade School	-	-														-		-						
Energy Generation & Distribution Facilities	-	-														-		-						
Exhibit Halls & Convention Facilities	-	-														-		-						
<i>Flood</i> Control Facilities	L	L														L		L						
<i>Historical Buildings</i> Used for Purposes Not Otherwise Allowed	C	C														C		C						
Homeless Facilities:																								
Congregate Meal Facilities	-	-														-		-						
Emergency Shelters	-	-														-		-						
Homeless Day Centers	-	-														-		-						
Hospitals, Intermediate Care Facilities & Nursing Facilities	-	-														-		-						
Interpretive Centers	-	-														-		-						

Use Categories/ Subcategories [See Section 131.0112 for an explanation and descriptions of the Use Categories, Subcategories, and Separately Regulated Uses]	Zone Designator	Zones																						
	1st & 2nd >>	RE-	RS-														RX-		RT-					
	3rd >>	1-	1-														1-		1-					
	4th >>	1	2	3	1	2	3	4	5	6	7	8	9	10	11	12	13	14	1	2	1	2	3	4
Museums	C	C														C		C						
Major Transmission, Relay, or Communications Switching Stations	-	-														-		-						
Satellite <i>Antennas</i>	L	L														L		L						
<i>Social Service Institutions</i>	-	-														-		-						
Solar Energy Systems	L	L														L		L						
<i>Wireless Communication Facility:</i>																								
<i>Wireless communication facility in the public right-of-way with subterranean equipment adjacent to a non- residential use</i>	L	L														L		L						
<i>Wireless communication facility in the public right-of-way with subterranean equipment adjacent to a residential use</i>	N	N														N		N						
<i>Wireless communication facility in the public right-of-way with above ground equipment</i>	C	C														C		C						
<i>Wireless communication facility outside the public right-of-way</i>	C	C														C		C						
Retail Sales																								
Building Supplies & Equipment	-	-														-		-						
Food, Beverages and Groceries	-	-														-		-						
Consumer Goods, Furniture, Appliances, Equipment	-	-														-		-						
Pets & Pet Supplies	-	-														-		-						
Sundries, Pharmaceuticals, & Convenience Sales	-	-														-		-						
Wearing Apparel & Accessories	-	-														-		-						

Use Categories/ Subcategories [See Section 131.0112 for an explanation and descriptions of the Use Categories, Subcategories, and Separately Regulated Uses]	Zone Designator	Zones																						
	1st & 2nd >>	RE-	RS-												RX-		RT-							
	3rd >>	1-	1-												1-		1-							
	4th >>	1	2	3	1	2	3	4	5	6	7	8	9	10	11	12	13	14	1	2	1	2	3	4
Separately Regulated Retail Sales Uses																								
Agriculture Related Supplies & Equipment	-	-												-	-									
Alcoholic Beverage Outlets	-	-												-	-									
Farmers' Markets																								
Weekly Farmers' Markets	-	-												-	-									
Daily Farmers' Market Stands	-	-												-	-									
Plant Nurseries	-	-												-	-									
Retail Farms	-	-												-	-									
Retail Tasting Stores	-	-												-	-									
Swap Meets & Other Large Outdoor Retail Facilities	-	-												-	-									
Commercial Services																								
Building Services	-	-												-	-									
Business Support	-	-												-	-									
Eating & Drinking Establishments	-	-												-	-									
Financial Institutions	-	-												-	-									
Funeral & Mortuary Services	-	-												-	-									
Instructional Studios	-	-												-	-									
Maintenance & Repair	-	-												-	-									
Off-Site Services	-	-												-	-									
Personal Services	-	-												-	-									
Radio & Television Studios	-	-												-	-									
Tasting Rooms	-	-												-	-									
Visitor Accommodations	-	-												-	-									
Separately Regulated Commercial Services Uses																								

Use Categories/ Subcategories [See Section 131.0112 for an explanation and descriptions of the Use Categories, Subcategories, and Separately Regulated Uses]	Zone Designator	Zones																						
	1st & 2nd >>	RE-	RS-												RX-		RT-							
	3rd >>	1-	1-												1-		1-							
	4th >>	1	2	3	1	2	3	4	5	6	7	8	9	10	11	12	13	14	1	2	1	2	3	4
Adult Entertainment Establishments:																								
Adult Book Store	-	-												-		-								
Adult Cabaret	-	-												-		-								
Adult Drive-In Theater	-	-												-		-								
Adult Mini-Motion Picture Theater	-	-												-		-								
Adult Model Studio	-	-												-		-								
Adult <i>Motel</i>	-	-												-		-								
Adult Motion Picture Theater	-	-												-		-								
Adult Peep Show Theater	-	-												-		-								
Adult Theater	-	-												-		-								
Body Painting Studio	-	-												-		-								
Massage Establishment	-	-												-		-								
Sexual Encounter Establishment	-	-												-		-								
Assembly and Entertainment Uses, Including Places of Religious Assembly	-	-												-		-								
Bed & Breakfast Establishments:																								
1-2 Guest Rooms	N	N												N		-								
3-5 Guest Rooms	N	C												C		-								
6+ Guest Rooms	C	C												-		-								
Boarding Kennels / Pet Day Care	-	-												-		-								
Camping Parks	-	-												-		-								
<i>Child Care Facilities:</i>																								
Child Care Centers	C	C												C		C								
Large Family Child Care Homes	L	L												L		L								
Small Family Child Care Homes	L	L												L		L								

Use Categories/ Subcategories [See Section 131.0112 for an explanation and descriptions of the Use Categories, Subcategories, and Separately Regulated Uses]	Zone Designator		Zones																					
	1st & 2nd >>	RE-	RS-														RX-		RT-					
	3rd >>	1-	1-														1-		1-					
	4th >>	1	2	3	1	2	3	4	5	6	7	8	9	10	11	12	13	14	1	2	1	2	3	4
Eating and Drinking Establishments with a Drive-in or Drive-through Component	-	-																						
Fairgrounds	-	-																						
Golf Courses, Driving Ranges, and Pitch & Putt Courses	C	C																						
Helicopter Landing Facilities	-	-																						
Massage Establishments, Specialized Practice	-	-																						
<i>Medical Marijuana Consumer Cooperatives</i>	-	-																						
Mobile Food Trucks	-	-																						
Nightclubs & Bars over 5,000 square feet in size	-	-																						
Parking Facilities as a <i>Primary Use</i> :																								
Permanent Parking Facilities	-	-																						
Temporary Parking Facilities	-	-																						
Private Clubs, Lodges and Fraternal Organizations	-	-																						
Privately Operated, Outdoor Recreation Facilities Over 40,000 Square Feet in Size ⁽⁴⁾	-	-																						
Pushcarts:																								
Pushcarts on Private Property	-	-																						
Pushcarts in <i>Public Right-of-Way</i>	-	-																						
Recycling Facilities:																								
Large Collection Facility	-	-																						

Use Categories/ Subcategories [See Section 131.0112 for an explanation and descriptions of the Use Categories, Subcategories, and Separately Regulated Uses]	Zone Designator	Zones																						
	1st & 2nd >>	RE-	RS-												RX-		RT-							
	3rd >>	1-	1-												1-		1-							
	4th >>	1	2	3	1	2	3	4	5	6	7	8	9	10	11	12	13	14	1	2	1	2	3	4
Small Collection Facility	-	-																						
Large Construction & Demolition Debris <i>Recycling Facility</i>	-	-																						
Small Construction & Demolition Debris <i>Recycling Facility</i>	-	-																						
Drop-off Facility	-	-																						
Green Materials Composting Facility	-	-																						
Mixed Organic Composting Facility	-	-																						
Large Processing Facility Accepting at Least 98% of Total Annual Weight of Recyclables from Commercial & Industrial Traffic	-	-																						
Large Processing Facility Accepting All Types of Traffic	-	-																						
Small Processing Facility Accepting at Least 98% of Total Annual Weight of Recyclables From Commercial & Industrial Traffic	-	-																						
Small Processing Facility Accepting All Types of Traffic	-	-																						
Reverse Vending Machines	-	-																						
Tire Processing Facility	-	-																						
Sidewalk Cafes	-	-																						
Sports Arenas & Stadiums	-	-																						
Theaters that are Outdoor or Over 5,000 Square Feet in Size	-	-																						
Urgent Care Facilities	-	-																						
Veterinary Clinics & Animal Hospitals	-	-																						

Use Categories/ Subcategories [See Section 131.0112 for an explanation and descriptions of the Use Categories, Subcategories, and Separately Regulated Uses]	Zone Designator	Zones																						
	1st & 2nd >>	RE-	RS-												RX-		RT-							
	3rd >>	1-	1-												1-		1-							
	4th >>	1	2	3	1	2	3	4	5	6	7	8	9	10	11	12	13	14	1	2	1	2	3	4
Zoological Parks	-	-												-		-								
Offices																								
Business & Professional	-	-												-		-								
Government	-	-												-		-								
Medical, Dental, & Health Practitioner	-	-												-		-								
Regional & Corporate Headquarters	-	-												-		-								
Separately Regulated Office Uses																								
Real Estate Sales Offices & Model Homes	L	L												L		L								
<i>Sex Offender</i> Treatment & Counseling	-	-												-		-								
Vehicle & Vehicular Equipment Sales & Service																								
Commercial Vehicle Repair & Maintenance	-	-												-		-								
Commercial Vehicle Sales & Rentals	-	-												-		-								
Personal Vehicle Repair & Maintenance	-	-												-		-								
Personal Vehicle Sales & Rentals	-	-												-		-								
Vehicle Equipment & Supplies Sales & Rentals	-	-												-		-								
Separately Regulated Vehicle & Vehicular Equipment Sales & Service Uses																								
Automobile Service Stations	-	-												-		-								
Outdoor Storage & Display of New, Unregistered Motor Vehicles as a	-	-												-		-								

Use Categories/ Subcategories [See Section 131.0112 for an explanation and descriptions of the Use Categories, Subcategories, and Separately Regulated Uses]	Zone Designator	Zones																						
	1st & 2nd >>	RE-	RS-														RX-		RT-					
	3rd >>	1-	1-														1-		1-					
	4th >>	1	2	3	1	2	3	4	5	6	7	8	9	10	11	12	13	14	1	2	1	2	3	4
Processing & Packaging of Plant Products & Animal By-products Grown Off-premises	-	-														-		-						
Very Heavy Industrial Uses	-	-														-		-						
Wrecking & Dismantling of Motor Vehicles	-	-														-		-						
Signs																								
Allowable Signs	P	P														P		P						
Separately Regulated Signs Uses																								
Community Entry Signs	L	L														L		L						
Neighborhood Identification Signs	N	N														N		N						
Comprehensive Sign Program	-	-														-		-						
Revolving Projecting Signs	-	-														-		-						
Signs with Automatic Changing Copy	-	-														-		-						
Theater Marquees	-	-														-		-						

Use Categories/ Subcategories [See Section 131.0112 for an explanation and descriptions of the Use Categories, Subcategories, and Separately Regulated Uses]	Zone Designator	Zones											
	1st & 2nd >>	RM-											
	3rd >>	1-			2-			3-			4-		5-
	4th >>	1	2	3	4	5	6	7	8	9	10	11	12
Open Space													
Active Recreation		P			P			P			P		P
Passive Recreation		P			P			P			P		P
Natural Resources Preservation		P			P			P			P		P
Park Maintenance Facilities		-			-			-			-		-
Agriculture													
Agricultural Processing		-			-			-			-		-
Aquaculture Facilities		-			-			-			-		-
Dairies		-			-			-			-		-
Horticulture Nurseries & Greenhouses		-			-			-			-		-
Raising & Harvesting of Crops		-			-			-			-		-
Raising, Maintaining & Keeping of Animals		-			-			-			-		-
Separately Regulated Agriculture Uses													
Agricultural Equipment Repair Shops		-			-			-			-		-
Commercial Stables		-			-			-			-		-
Community Gardens		L			L			L			L		L
Equestrian Show & Exhibition Facilities		-			-			-			-		-
Open Air Markets for the Sale of Agriculture- Related Products & Flowers		-			-			-			-		-

Use Categories/ Subcategories [See Section 131.0112 for an explanation and descriptions of the Use Categories, Subcategories, and Separately Regulated Uses]	Zone Designator	Zones												
	1st & 2nd >>	RM-												
	3rd >>	1-			2-			3-			4-		5-	
	4th >>	1	2	3	4	5	6	7	8	9	10	11	12	
Residential														
<i>Mobilehome Parks</i>		P ⁽²⁾			P ⁽²⁾			P ⁽²⁾			P ⁽²⁾		-	
<i>Multiple Dwelling Units</i>		P ⁽⁵⁾			P ⁽⁵⁾			P ⁽⁵⁾			P ⁽⁵⁾		P	
<i>Rooming House</i> [See Section 131.0112(a)(3)(A)]		P			P			P			P		P	
<i>Shopkeeper Units</i>		-			-			P			P		P	
<i>Single Dwelling Units</i>		P ⁽¹²⁾			P ⁽¹²⁾			P ⁽¹²⁾			P ⁽¹²⁾		P ⁽¹²⁾	
Separately Regulated Residential Uses														
<i>Boarder & Lodger Accommodations</i>		L			L			L			L		L	
<i>Companion Units</i>		L			L			L			L		L	
<i>Employee Housing:</i>														
6 or Fewer Employees		-			-			-			-		-	
12 or Fewer Employees		-			-			-			-		-	
Greater than 12 Employees		-			-			-			-		-	
<i>Fraternities, Sororities and Student Dormitories</i>		C			C			C			C		-	
<i>Garage, Yard, & Estate Sales</i>		L			L			L			L		-	
<i>Guest Quarters</i>		L ⁽¹⁰⁾			-			-			-		-	
<i>Home Occupations</i>		L			L			L			L		-	
<i>Housing for Senior Citizens</i>		C			C			C			C		-	
<i>Live/Work Quarters</i>		-			-			-			-		-	

Use Categories/ Subcategories [See Section 131.0112 for an explanation and descriptions of the Use Categories, Subcategories, and Separately Regulated Uses]	Zone Designator	Zones											
	1st & 2nd >>	RM-											
	3rd >>	1-			2-			3-			4-		5-
	4th >>	1	2	3	4	5	6	7	8	9	10	11	12
Residential Care Facilities:													
6 or fewer persons		P			P			P			P		-
7 or more persons		C			C			C			C		-
Transitional Housing:													
6 or fewer persons		P			P			P			P		-
7 or more persons		C			C			C			C		-
Watchkeeper Quarters		-			-			-			-		-
Institutional													
Separately Regulated Institutional Uses													
Airports		-			-			-			-		-
Botanical Gardens & Arboretums		C			C			C			C		-
Cemeteries, Mausoleums, Crematories		-			-			-			-		-
Correctional Placement Centers		-			-			-			-		-
Educational Facilities:													
Kindergarten through Grade 12		P			P			P			P		-
Colleges / Universities		C			C			C			C		
Vocational / Trade School		-			-			-			-		-
Energy Generation & Distribution Facilities		-			-			-			C		C
Exhibit Halls & Convention Facilities		-			-			-			-		-

Use Categories/ Subcategories [See Section 131.0112 for an explanation and descriptions of the Use Categories, Subcategories, and Separately Regulated Uses]	Zone Designator	Zones												
	1st & 2nd >>	RM-												
	3rd >>	1-			2-			3-			4-		5-	
	4th >>	1	2	3	4	5	6	7	8	9	10	11	12	
<i>Flood Control Facilities</i>		L			L			L			L		-	
<i>Historical Buildings Used for Purposes Not Otherwise Allowed</i>		C			C			C			C		C	
Homeless Facilities:														
Congregate Meal Facilities		-			-			C			C		-	
Emergency Shelters		-			-			C			C		-	
Homeless Day Centers		-			-			C			C		-	
Hospitals, Intermediate Care Facilities & Nursing Facilities		C			C			C			C		-	
Interpretive Centers		-			-			-			-		-	
Museums		-			-			-			-		-	
Major Transmission, Relay, or Communications Switching Stations		-			-			-			-		-	
<i>Satellite Antennas</i>		L			L			L			L		L	
<i>Social Service Institutions</i>		-			-			-			-		-	
Solar Energy Systems		L			L			L			L		L	
<i>Wireless Communication Facility:</i>														

Use Categories/ Subcategories [See Section 131.0112 for an explanation and descriptions of the Use Categories, Subcategories, and Separately Regulated Uses]	Zone Designator	Zones											
	1st & 2nd >>	RM-											
	3rd >>	1-			2-			3-			4-		5-
	4th >>	1	2	3	4	5	6	7	8	9	10	11	12
<i>Wireless communication facility in the public right-of-way with subterranean equipment adjacent to a non-residential use</i>		L			L			L			L		L
<i>Wireless communication facility in the public right-of-way with subterranean equipment adjacent to a residential use</i>		N			N			N			N		N
<i>Wireless communication facility in the public right-of-way with above ground equipment</i>		C			C			C			C		C
<i>Wireless communication facility outside the public right-of-way</i>		C			C			C			C		C
Retail Sales													
Building Supplies & Equipment		-			-			-			-		-
Food, Beverages and Groceries		-			-			P ⁽⁷⁾			P ⁽⁷⁾		P ⁽⁷⁾
Consumer Goods, Furniture, Appliances, Equipment		-			-			-			-		-
Pets & Pet Supplies		-			-			-			-		-
Sundries, Pharmaceuticals, & Convenience Sales		-			-			P ⁽⁷⁾			P ⁽⁷⁾		P ⁽⁷⁾
Wearing Apparel & Accessories		-			-			P			P		P
Separately Regulated Retail Sales Uses													

Use Categories/ Subcategories [See Section 131.0112 for an explanation and descriptions of the Use Categories, Subcategories, and Separately Regulated Uses]	Zone Designator	Zones											
	1st & 2nd >>	RM-											
	3rd >>	1-			2-			3-			4-		5-
	4th >>	1	2	3	4	5	6	7	8	9	10	11	12
Agriculture Related Supplies & Equipment		-			-			-			-		-
Alcoholic Beverage Outlets		-			-			-			-		-
Farmers' Markets													
Weekly Farmers' Markets		-			-			-			-		-
Daily Farmers' Market Stands		-			-			-			-		-
Plant Nurseries		-			-			-			-		-
Retail Farms		-			-			-			-		-
Retail Tasting Stores		-			-			-			-		-
Swap Meets & Other Large Outdoor Retail Facilities		-			-			-			-		-
Commercial Services													
Building Services		-			-			-			-		-
Business Support		-			-			p ⁽⁷⁾			p ⁽⁷⁾		p ⁽⁷⁾
Eating & Drinking Establishments		-			-			-			-		-
Financial Institutions		-			-			-			-		-
Funeral & Mortuary Services		-			-			-			-		-
Instructional Studios		P			P			P			P		P
Maintenance & Repair		-			-			-			-		-
Off-Site Services		-			-			-			-		-
Personal Services		-			-			p ⁽⁷⁾			p ⁽⁷⁾		p ⁽⁷⁾
Radio & Television Studios		-			-			-			-		-
Tasting Rooms		-			-			-			-		-
Visitor Accommodations		-			-			-			p ⁽⁶⁾		p ⁽⁶⁾

Use Categories/ Subcategories [See Section 131.0112 for an explanation and descriptions of the Use Categories, Subcategories, and Separately Regulated Uses]	Zone Designator	Zones												
	1st & 2nd >>	RM-												
	3rd >>	1-			2-			3-			4-		5-	
	4th >>	1	2	3	4	5	6	7	8	9	10	11	12	
Separately Regulated Commercial Services Uses														
Adult Entertainment Establishments:														
Adult Book Store		-	-	-	-	-	-	-	-	-	-	-	-	
Adult Cabaret		-	-	-	-	-	-	-	-	-	-	-	-	
Adult Drive-In Theater		-	-	-	-	-	-	-	-	-	-	-	-	
Adult Mini-Motion Picture Theater		-	-	-	-	-	-	-	-	-	-	-	-	
Adult Model Studio		-	-	-	-	-	-	-	-	-	-	-	-	
Adult <i>Motel</i>		-	-	-	-	-	-	-	-	-	-	-	-	
Adult Motion Picture Theater		-	-	-	-	-	-	-	-	-	-	-	-	
Adult Peep Show Theater		-	-	-	-	-	-	-	-	-	-	-	-	
Adult Theater		-	-	-	-	-	-	-	-	-	-	-	-	
Body Painting Studio		-	-	-	-	-	-	-	-	-	-	-	-	
Massage Establishment		-	-	-	-	-	-	-	-	-	-	-	-	
Sexual Encounter Establishment		-	-	-	-	-	-	-	-	-	-	-	-	
Assembly and Entertainment Uses, Including Places of Religious Assembly		L	L	L	L	L	L	L	L	L	L	L	L	
Bed & Breakfast Establishments:														
1-2 Guest Rooms		L	L	L	L	L	L	L	L	P	P	P	P	
3-5 Guest Rooms		N	N	N	N	N	N	N	N	L	P	P	P	
6+ Guest Rooms		C	C	C	C	C	C	C	C	N	P	P	P	
Boarding Kennels/ Pet Day Care		-	-	-	-	-	-	-	-	-	-	-	-	
Camping Parks		-	-	-	-	-	-	-	-	-	-	-	-	

Use Categories/ Subcategories [See Section 131.0112 for an explanation and descriptions of the Use Categories, Subcategories, and Separately Regulated Uses]	Zone Designator	Zones												
	1st & 2nd >>	RM-												
	3rd >>	1-			2-			3-			4-		5-	
	4th >>	1	2	3	4	5	6	7	8	9	10	11	12	
<i>Child Care Facilities:</i>														
Child Care Centers		C			C			C			C		-	
Large Family Child Care Homes		L			L			L			L		-	
Small Family Child Care Homes		L			L			L			L		-	
Eating and Drinking Establishments with a Drive-in or Drive-through Component		-			-			-			-		-	
Fairgrounds		-			-			-			-		-	
Golf Courses, Driving Ranges, and Pitch & Putt Courses		C			C			C			C		-	
Helicopter Landing Facilities		-			-			-			-		-	
Massage Establishments, Specialized Practice		-			-			-			-		-	
<i>Medical Marijuana Consumer Cooperatives</i>		-			-			-			-		-	
Mobile Food Trucks		-			N			L ⁽¹¹⁾			L ⁽¹¹⁾		L ⁽¹¹⁾	
Nightclubs & Bars over 5,000 square feet in size		-			-			-			-		-	
<i>Parking Facilities as a Primary Use:</i>														
Permanent Parking Facilities		-			-			-			-		-	
Temporary Parking Facilities		-			-			-			-		-	
Private Clubs, Lodges and Fraternal Organizations		-			-			-			-		P	
Privately Operated, Outdoor Recreation Facilities over 40,000 square feet in size ⁽⁴⁾		-			-			-			-		-	
<i>Pushcarts:</i>														

Use Categories/ Subcategories [See Section 131.0112 for an explanation and descriptions of the Use Categories, Subcategories, and Separately Regulated Uses]	Zone Designator	Zones											
	1st & 2nd >>	RM-											
	3rd >>	1-			2-			3-			4-		5-
	4th >>	1	2	3	4	5	6	7	8	9	10	11	12
Pushcarts on Private Property		-			-			-			-		
Pushcarts in Public Right of Way		-			-			-			-		
Recycling Facilities:													
Large Collection Facility		-			-			-			-		
Small Collection Facility		-			-			-			-		
Large Construction & Demolition Debris <i>Recycling Facility</i>		-			-			-			-		
Small Construction & Demolition Debris <i>Recycling Facility</i>		-			-			-			-		
Drop-off Facility		-			-			-			-		
Green Materials Composting Facility		-			-			-			-		
Mixed Organic Composting Facility		-			-			-			-		
Large Processing Facility Accepting at Least 98% of Total Annual Weight of Recyclables from Commercial & Industrial Traffic		-			-			-			-		
Large Processing Facility Accepting All Types of Traffic		-			-			-			-		
Small Processing Facility Accepting at Least 98% of Total Annual Weight of Recyclables From Commercial & Industrial Traffic		-			-			-			-		

Use Categories/ Subcategories [See Section 131.0112 for an explanation and descriptions of the Use Categories, Subcategories, and Separately Regulated Uses]	Zone Designator	Zones											
	1st & 2nd >>	RM-											
	3rd >>	1-			2-			3-			4-		5-
	4th >>	1	2	3	4	5	6	7	8	9	10	11	12
Small Processing Facility Accepting All Types of Traffic		-			-			-			-		-
Reverse Vending Machines		-			-			-			-		-
Tire Processing Facility		-			-			-			-		-
Sidewalk Cafes		-			-			-			-		-
Sports Arenas & Stadiums		-			-			-			-		-
Theaters That Are Outdoor or over 5,000 Square Feet in Size		-			-			-			-		-
Urgent Care Facility		-			-			-			-		-
Veterinary Clinics & Animal Hospitals		-			-			-			-		-
Zoological Parks		-			-			-			-		-
Offices													
Business & Professional		-			-			P ⁽⁷⁾			P ⁽⁷⁾		P ⁽⁷⁾
Government		-			-			-			-		-
Medical, Dental, & Health Practitioner		-			-			P ⁽⁷⁾			P ⁽⁷⁾		P ⁽⁷⁾
Regional & Corporate Headquarters		-			-			-			-		-
Separately Regulated Office Uses													
Real Estate Sales Offices & Model Homes		L			L			L			L		-

Use Categories/ Subcategories [See Section 131.0112 for an explanation and descriptions of the Use Categories, Subcategories, and Separately Regulated Uses]	Zone Designator	Zones											
	1st & 2nd >>	RM-											
	3rd >>	1-			2-			3-			4-		5-
	4th >>	1	2	3	4	5	6	7	8	9	10	11	12
<i>Sex Offender Treatment & Counseling</i>		-			-			L			L		-
Vehicle & Vehicular Equipment Sales & Service													
Commercial Vehicle Repair & Maintenance		-			-			-			-		-
Commercial Vehicle Sales & Rentals		-			-			-			-		-
Personal Vehicle Repair & Maintenance		-			-			-			-		-
Personal Vehicle Sales & Rentals		-			-			-			-		-
Vehicle Equipment & Supplies Sales & Rentals		-			-			-			-		-
Separately Regulated Vehicle & Vehicular Equipment Sales & Service Uses													
Automobile Service Stations		-			-			-			-		-
Outdoor Storage & Display of New, Unregistered Motor Vehicles as a <i>Primary Use</i>		-			-			-			-		-
Distribution and Storage													
Equipment & Materials Storage Yards		-			-			-			-		-
Moving & Storage Facilities		-			-			-			-		-
Distribution Facilities		-			-			-			-		-
Separately Regulated Distribution and Storage Uses													
Impound Storage Yards		-			-			-			-		-
Junk Yards		-			-			-			-		-

Use Categories/ Subcategories [See Section 131.0112 for an explanation and descriptions of the Use Categories, Subcategories, and Separately Regulated Uses]	Zone Designator	Zones											
	1st & 2nd >>	RM-											
	3rd >>	1-			2-			3-			4-		5-
	4th >>	1	2	3	4	5	6	7	8	9	10	11	12
Temporary Construction Storage Yards Located off-site		N			N			N			N		-
Industrial													
Heavy Manufacturing		-	-	-	-	-	-	-	-	-	-	-	-
Light Manufacturing		-	-	-	-	-	-	-	-	-	-	-	-
Marine Industry		-	-	-	-	-	-	-	-	-	-	-	-
Research & Development		-	-	-	-	-	-	-	-	-	-	-	-
Trucking & Transportation Terminals		-	-	-	-	-	-	-	-	-	-	-	-
Separately Regulated Industrial Uses													
<i>Hazardous Waste</i> Research Facility		-	-	-	-	-	-	-	-	-	-	-	-
<i>Hazardous Waste</i> Treatment Facility		-	-	-	-	-	-	-	-	-	-	-	-
Marine Related Uses Within the Coastal Overlay Zone		-	-	-	-	-	-	-	-	-	-	-	-
Mining and Extractive Industries		-	-	-	-	-	-	-	-	-	-	-	-
Newspaper Publishing Plants		-	-	-	-	-	-	-	-	-	-	-	-
Processing & Packaging of Plant Products & Animal By-products Grown Off-premises		-	-	-	-	-	-	-	-	-	-	-	-
Very Heavy Industrial Uses		-	-	-	-	-	-	-	-	-	-	-	-
Wrecking & Dismantling of Motor Vehicles		-	-	-	-	-	-	-	-	-	-	-	-
Signs													

Use Categories/ Subcategories [See Section 131.0112 for an explanation and descriptions of the Use Categories, Subcategories, and Separately Regulated Uses]	Zone Designator	Zones												
	1st & 2nd >>	RM-												
	3rd >>	1-			2-			3-			4-		5-	
	4th >>	1	2	3	4	5	6	7	8	9	10	11	12	
Allowable Signs		P			P			P			P		P	
Separately Regulated Signs Uses														
Community Entry Signs		L			L			L			L		L	
Neighborhood Identification Signs		N			N			N			N		N	
Comprehensive Sign Program		-			-			-			-		-	
Revolving Projecting Signs		-			-			-			-		-	
Signs with Automatic Changing Copy		-			-			-			-		-	
Theater Marquees		-												

Footnotes for Table 131-04B

- ¹ Development of a mobilehome park in any RS or RX zone is subject to Section 143.0302.
- ² Development of a mobilehome park in the RM zones is subject to Section 143.0302.
- ³ This use is permitted only if as an *accessory use*, but shall not be subject to the *accessory use* regulations in Section 131.0125.
- ⁴ The 40,000 square feet includes all indoor and outdoor areas that are devoted to the recreational use; it does not include customer parking areas.
- ⁵ Non-owner occupants must reside on the *premises* for at least 7 consecutive calendar days.
- ⁶ Two *guest rooms* are permitted for visitor accommodations per the specified square footage of lot area required per dwelling unit (maximum permitted *density*), as indicated on Table 131-04G.
- ⁷ See Section 131.0423.
- ⁸ Maintaining, raising, feeding, or keeping of 10 or more domestic animals requires a *premises* of at least 5 acres. Maintaining, raising, feeding, or keeping of swine is not permitted.
- ⁹ A Residential High Occupancy Permit is required in accordance with Section 123.0502 for a *single dwelling unit* when the occupancy of the *dwelling unit* would consist of six or more persons eighteen years of age and older residing in the *dwelling unit* for a period of 30 or more consecutive days.
- ¹⁰ A guest quarters or habitable accessory building is permitted in accordance with Section 141.0306 only as an *accessory use* to a *single dwelling unit*.

- 11 This use is permitted by right on the property of a *school*, university, hospital, religious facility, or construction site. It is permitted as a limited use only in association with a *multiple dwelling unit development* with at least 16 *dwelling units* and only if the commercial service is limited to the residents and their guests, and the use is designed and operated in compliance with Section 141.0612.
- 12 *Development* of a small *lot subdivision* is permitted in accordance with Section 143.0365.

(Amended 8-10-2004 by O-19308 N.S.; effective 4-11-2007.)
(Amended 1-29-2008 by O-19704 N.S.; effective 2-28-2008.)
(Amended 4-23-2008 by O-19739 N.S.; effective 5-23-2008.)
(Amended 11-13-08 by O-19799 N.S.; effective 12-13-2008.)
(Amended 11-13-08 by O-19803 N.S.; effective 12-13-2008.)
(Amended 11-13-08 by O-19804 N.S.; effective 12-13-2008.)
(Amended 7-6-2011 by O-20065 N.S.; effective 8-5-2011.)
(Amended 8-4-2011 by O-20081 N.S.; effective 10-6-2011.)
(Amended 2-22-2012 by O-20141 N.S.; effective 3-23-2012.)
(Amended 6-18-2013 by O-20261 N.S.; effective 7-19-2013.)
(Amended 3-25-2014 by O-20356 N.S.; effective 4-24-2014.)
(Amended 4-3-2014 by O-20357 N.S.; effective 10-15-2014.)
(Amended 5-5-2015 by O-20481 and O-20483 N.S.; effective 6-4-2015)
(Amended 7-10-2015 by O-20512 N.S.; effective 8-9-2015.)
(Amended 8-7-2015 by O-20555 N.S.; effective 9-6-2015.)
(Amended 10-15-2015 by O-20567 N.S.; effective 11-14-2015.)

[Editors Note: Amendments as adopted by O-20567 N.S. will not apply within the Coastal Overlay Zone until the California Coastal Commission certifies it as a Local Coastal Program Amendment.

Click the link to view the Strikeout Ordinance highlighting changes to prior language http://docs.sandiego.gov/municode_strikeout_ord/O-20567-SO.pdf]

§131.0423 Additional Use Regulations for Residential Zones

The additional use regulations identified in this section are applicable to retail sales, commercial services, and office uses where indicated in Table 131-04B.

- (a) Medical, dental, and health practitioner offices that do not allow overnight patients are permitted.
- (b) Use is permitted only in a mixed-use *development* where the *density* complies with the applicable *land use plan*.
- (c) Use may be located only on the ground *floor*.
- (d) Operation shall be limited to hours between 6:00 a.m. and 10:00 p.m.

(Added 12-9-1997 by O-18451 N.S.; effective 1-1-2000.)
(Amended 4-23-2008 by O-19739 N.S.; effective 5-23-2008.)
(Amended 6-18-2013 by O-20261 N.S.; effective 7-19-2013.)
(Amended 7-10-2015 by O-20512 N.S.; effective 8-9-2015.)

§131.0430 Development Regulations of Residential Zones

- (a) Within the residential zones, no *structure* or improvement shall be constructed, established, or altered, nor shall any *premises* be used unless the *premises* complies with the regulations and standards in this division and with any applicable development regulations in Chapter 13, Article 2 (Overlay Zones) and Chapter 14 (General and Supplemental Regulations).
- (b) A Neighborhood Development Permit or Site Development Permit is required for the types of *development* identified in Table 143-03A.
- (c) The regulations in this division apply to all *development* in the residential base zones whether or not a permit or other approval is required except where specifically identified.

(Added 12-9-1997 by O-18451 N.S.)
(Amended 10-18-1999 by O-18691 N.S.; effective 1-1-2000.)

§131.0431 Development Regulations Table for Residential Zones

The following development regulations apply in the residential zones as shown in Tables 131-04C, 131-04D, 131-04E, 131-04F, and 131-04G.

(a) RE Zones

**Table 131-04C
Development Regulations for RE Zones**

Development Regulations [See Section 131.0430 for Development Regulations of Residential Zones]	Zone designator	Zones		
	1st & 2nd >>	RE-		
	3rd >>	1-	1-	1-
	4th >>	1	2	3
Max permitted density (DU per lot)		1	1	1
Min lot area (ac)		10	5	1
Min lot dimensions				
Lot width (ft)		200	200	100
<i>street frontage</i> (ft) [See Section 131.0442(a)]		200	200	100
Lot width (corner) (ft)		200	200	100
Lot depth (ft)		200	200	150
Setback requirements				
Min Front <i>setback</i> (ft) [See Section 131.0443(a)(1) and (2)]		25	25	25
Min Side <i>setback</i> (ft) [See Section 131.0443(a)(3)]		20	20	20
Min <i>Street side setback</i> (ft) [See Section 131.0443(a)(3)]		20	20	20
Min Rear <i>setback</i> (ft) [See Section 131.0443(a)(4)]		25	25	25
Setback requirements for resubdivided corner lots [See Section 113.0246(f)]		applies	applies	applies
Max structure height (ft) [See Section 131.0444(a)]		30	30	30
Lot coverage for sloping lots [See Section 131.0445(a)]		applies	applies	applies

Development Regulations [See Section 131.0430 for Development Regulations of Residential Zones]	Zone designator	Zones		
	1st & 2nd >>	RE-		
	3rd >>	1-	1-	1-
	4th >>	1	2	3
Max floor area ratio		0.10	0.20	0.35
Max paving/ hardscape [See Section 131.0447]		applies	applies	applies
Accessory uses and structures [See Sections 131.0448 and 141.0306]		applies	applies	applies
Garage regulations [See Section 131.0449(a)]		applies	applies	Applies
Building spacing [See Section 131.0450]		applies	applies	applies
Max third story dimensions		--	--	--
Architectural projections and encroachments		--	--	--
Supplemental requirements [See Section 131.0464(a)]		applies	applies	applies
Refuse and Recyclable Material Storage [See Section 142.0805]		applies	applies	Applies

(b) RS Zones

**Table 131-04D
Development Regulations for RS Zones**

Development Regulations [See Section 131.0430 for Development Regulations of Residential Zones]	Zone Designator	Zones						
	1st & 2nd >>	RS-						
	3rd >>	1-	1-	1-	1-	1-	1-	1-
	4th >>	1	2	3	4	5	6	7
Max permitted density (DU per lot)		1	1	1	1	1	1	1
Min lot area (sf)		40,000	20,000	15,000	10,000	8,000	6,000	5,000
Min lot dimensions								
Lot width (ft)		100	80	75	65	60	60	50
Street frontage (ft) [See Section 131.0442(a)]		100	80	75	65	60	60	50
Lot width (corner) (ft)		110	85	80	70	65	65	55
Lot depth (ft)		100	100	100	100	100	95	95
Setback requirements								
Min Front setback (ft)		25 ⁽¹⁾	25 ⁽¹⁾	20 ⁽¹⁾	20 ⁽¹⁾	20 ⁽¹⁾	15 ⁽¹⁾	15 ⁽¹⁾
Min Side setback (ft) [Multiply number in table by actual lot width to calculate setback]		.08 ⁽²⁾	.08 ⁽²⁾	.08 ⁽²⁾	.08 ⁽²⁾	.08 ⁽²⁾	.08 ⁽²⁾	.08 ⁽²⁾
Min Street side setback (ft) [Multiply number in table by actual lot width to calculate setback]		.10 ⁽²⁾	.10 ⁽²⁾	.10 ⁽²⁾	.10 ⁽²⁾	.10 ⁽²⁾	.10 ⁽²⁾	.10 ⁽²⁾
Min Rear setback (ft)		25 ⁽³⁾	25 ⁽³⁾	20 ⁽³⁾	20 ⁽³⁾	20 ⁽³⁾	15 ⁽³⁾	13 ⁽³⁾
Setback requirements for resubdivided corner lots [See Section 113.0246(f)]		applies	applies	applies	applies	applies	applies	applies
Max structure height (ft)		24/30 ⁽⁴⁾	24/30 ⁽⁴⁾	24/30 ⁽⁴⁾	24/30 ⁽⁴⁾	24/30 ⁽⁴⁾	24/30 ⁽⁴⁾	24/30 ⁽⁴⁾

Development Regulations [See Section 131.0430 for Development Regulations of Residential Zones]	Zone Designator	Zones						
	1st & 2nd >>	RS-						
	3rd >>	1-	1-	1-	1-	1-	1-	1-
	4th >>	1	2	3	4	5	6	7
Lot coverage for sloping lots [See Section 131.0445(a)]		applies	applies	applies	applies	applies	applies	applies
Max floor area ratio		0.45	varies ⁽⁵⁾	varies ⁽⁵⁾	varies ⁽⁵⁾	varies ⁽⁵⁾	varies ⁽⁵⁾	varies ⁽⁵⁾
Max paving/ hardscape [See Section 131.0447]		applies	applies	applies	applies	applies	applies	applies
Accessory uses and structures [See Sections 131.0448 and 141.0306]		applies	applies	applies	applies	applies	applies	applies
Garage regulations [See Section 131.0449(a)]		applies	applies	applies	applies	applies	applies	applies
Building spacing [See Section 131.0450]		applies	applies	applies	applies	applies	applies	applies
Max third story dimensions [See Section 131.0460]		--	applies	applies	applies	applies	applies	applies
Architectural projections and encroachments [See Section 131.0461(a)]		applies	applies	applies	applies	applies	applies	applies
Supplemental requirements [See Section 131.0464(a)]		applies	applies	applies	applies	applies	applies	applies
Bedroom regulation		applies ⁽⁷⁾	applies ⁽⁷⁾	applies ⁽⁷⁾	applies ⁽⁷⁾	applies ⁽⁷⁾	applies ⁽⁷⁾	applies ⁽⁷⁾
Refuse and Recyclable Material Storage [See Section 142.0805]		applies	applies	applies	applies	applies	applies	Applies

Development Regulations [See Section 131.0430 for Development Regulations of Residential Zones]	Zone Designator	Zones						
		RS-						
	1st & 2nd >>	1-	1-	1-	1-	1-	1-	1-
	3rd >>	8	9	10	11	12	13	14
	4th >>							
Max permitted density (DU per lot)		1	1	1	1	1	1	1
Min lot area (sf)		40,000	20,000	15,000	10,000	8,000	6,000	5,000
Min lot dimensions								
Lot width (ft)		100	80	75	65	60	60	50
street frontage (ft) [See Section 131.0442(a)]		100	80	75	65	60	60	50
Lot width (corner) (ft)		110	85	80	70	65	65	55
Lot depth (ft)		100	100	100	100	100	95	95
Setback requirements								
Min Front setback (ft)		25 ⁽¹⁾	25 ⁽¹⁾	25 ⁽¹⁾	20 ⁽¹⁾	15 ⁽¹⁾	15 ⁽¹⁾	15 ⁽¹⁾
Min Side setback (ft)		10	8	7	6	5	5	4
Min Street side setback (ft)		20	15	15	10	10	10	10
Min Rear setback (ft)		10 ⁽⁶⁾	10 ⁽⁶⁾	10 ⁽⁶⁾	10 ⁽⁶⁾	10 ⁽⁶⁾	10 ⁽⁶⁾	10 ⁽⁶⁾
Setback requirements for resubdivided corner lots [See Section 113.0246(f)]		applies	applies	applies	applies	applies	applies	Applies
Max structure height (ft)		35	35	35	35	35	35	35
Lot coverage for sloping lots [See Section 131.0445(a)]		-	-	-	-	-	-	-
Max floor area ratio [See Section 131.0446(b)]		0.45	0.60	0.60	0.60	0.60	0.60	0.60
Max paving/ hardscape [See Section 131.0447]		applies	applies	applies	applies	applies	applies	applies
Accessory uses and structures [See Sections 131.0448 and 141.0306]		applies	applies	applies	applies	applies	applies	applies
Garage regulations [See Section 131.0449(a)]		applies	applies	applies	applies	applies	applies	applies
Building spacing [See Section 131.0450]		applies	applies	applies	applies	applies	applies	applies
Max third story dimensions		-	-	-	-	-	-	-
Architectural projections and encroachments [See Section 131.0461(a)]		applies	applies	applies	applies	applies	applies	applies
Supplemental requirements [See Section 131.0464(a)]		applies	applies	applies	applies	applies	applies	applies
Bedroom Regulation		applies ⁽⁷⁾	applies ⁽⁷⁾	applies ⁽⁷⁾	applies ⁽⁷⁾	applies ⁽⁷⁾	applies ⁽⁷⁾	applies ⁽⁷⁾
Refuse and Recyclable Material Storage [See Section 142.0805]		applies	applies	applies	applies	applies	applies	applies

Footnotes for Table 131-04D

- ¹ For *lots* where at least one-half of the front 50 feet of the *lot* depth has a minimum slope gradient of 25 percent, the *setback* closest to the *street frontage* may be reduced to a minimum 6 feet.
- ² For *lots* greater than 50 feet in width, the required side *setbacks* may be reallocated where the combined dimension of each side *setback* would meet or exceed the combined total required in Table 131-04D, in which case side *setbacks* shall not be reduced to less than 4 feet, and *street* side *setbacks* shall not be reduced to less than 10 feet. Once a side *setback* is reallocated and established at a dimension less than the percentage indicated in Table 131-04D, all additions to the *primary structure* thereafter shall maintain the established side *setback*.
- ³ See Section 131.0443(a)(2).
- ⁴ See Section 131.0444(b).
- ⁵ See Section 131.0446(a).
- ⁶ See Section 131.0443(a)(3).
- ⁷ On lots less than 10,000 square feet a single dwelling unit shall be limited to 6 bedrooms maximum

(c) RX Zones

Table 131-04E
Development Regulations for RX Zones

Development Regulations [See Section 131.0430 for Development Regulations of Residential Zones]	Zone Designator	Zones	
	1st & 2nd >>	RX-	
	3rd >>	1-	1-
	4th >>	1	2
Maximum Permitted <i>Density</i> (DU per <i>lot</i>)		1	1
Min Lot Area (sf) [See Section 131.0441]		4,000	3,000
Min lot dimensions			
Lot width (ft)		35	35 ⁽¹⁾
<i>street frontage</i> (ft) [See Section 131.0442(b)]		35	35 ⁽¹⁾
Lot width (corner) (ft)		35	35 ⁽¹⁾
Lot depth (ft)		50	50
Setback requirements			
Min Front <i>setback</i> (ft) [See Section 131.0443(b)(1)]		15	15
Min Side <i>setback</i> (ft) [See Section 131.0443(b)(2)]		3/0	3/0
Detached		0	0
Attached			
Min <i>Street Side Setback</i> (ft) [See Section 131.0443(b)(2)]		3	3
Min Rear <i>setback</i> (ft) [See Section 131.0443(b)(3)]		10	10
Max structure height (ft) [See Section 131.0444(c)]		30	30
Max floor area ratio [See Section 131.0446(c)]		0.70	0.80
Accessory uses and structures [See Sections 131.0448 and 141.0306]		applies	applies
Garage regulations [See Section 131.0449(a)]		applies	applies
Building spacing [See Section 131.0450]		applies	applies
Architectural projections and encroachments [See Section 131.0461(a)]		applies	applies

Development Regulations [See Section 131.0430 for Development Regulations of Residential Zones]	Zone Designator	Zones	
	1st & 2nd >>	RX-	
	3rd >>	1-	1-
	4th >>	1	2
Requirements for attached units [See Section 131.0462]		applies	applies
Roof design variation [See Section 131.0463]		applies	applies
Supplemental regulations [See Section 131.0464(b)]		applies	Applies
Refuse and Recyclable Material Storage [See Section 142.0805]		applies	applies

Footnote for Table 131-04E

¹ If a *lot* abuts an *alley*, see Section 131.0442(c).

(d) RT Zones

**Table 131-04F
Development Regulations for RT Zones**

Development Regulations [See Section 131.0430 for Development Regulations of Residential Zones]	Zone Designator	Zones				
	1st & 2nd >>	RT-				
	3rd >>	1-	1-	1-	1-	1-
	4th >>	1	2	3	4	5
Maximum Permitted <i>Density</i> (DU per lot)		1	1	1	1	1
Min <i>Lot Area</i> (sf) [See Section 131.0441]		3,500	3,000	2,500	2,200	1,600
Min <i>Lot Dimensions</i>						
Lot Width (ft)		25	25	25	25	18
<i>Street Frontage</i> (ft)		25	25	25	25	18
<i>Lot Width</i> (corner) (ft)		25	25	25	25	25
<i>Lot Depth</i> (ft)		100	100	90	80	80
Setback Requirements						
Min Front <i>Setback</i> (ft) [See Section 131.0443(c)(1)]		5	5	5	5	5
Max Front <i>Setback</i> (ft) [See Section 131.0443(c)(1)]		15	15	15	15	10
Side <i>Setback</i> (ft) [See Section 131.0443(c)(2)]		0	0	0	0	0

Development Regulations [See Section 131.0430 for Development Regulations of Residential Zones]	Zone Designator	Zones				
	1st & 2nd >>	RT-				
	3rd >>	1-	1-	1-	1-	1-
	4th >>	1	2	3	4	5
Min <i>Street Side Setback</i> (ft)		5	5	5	5	5
Min <i>Rear Setback</i> (ft)		3	3	3	3	3
Max <i>Structure Height</i> [See 131.0444(d)]						
1 and 2 <i>story</i> buildings (ft)						
<i>slab floor</i>		21	21	21	21	21
<i>raised floor</i>		25	25	25	25	25
3 <i>story</i> buildings (ft)						
<i>slab floor</i>		31	31	31	31	31
<i>raised floor</i>		35	35	35	35	35
Max <i>Lot Coverage</i> (%) [See Section 131.0445(b)]		60	65	70	75	75
Max <i>Floor Area Ratio</i> [See 131.0446(d)]						
1 and 2 <i>story</i> buildings		0.85	0.95	1.00	1.10	1.20
3 <i>story</i> buildings		1.20	1.30	1.40	1.50	1.60
<i>Accessory Uses and Structures</i> [See Sections 131.0448 and 141.0306]		applies	applies	applies	applies	applies
Garage Regulations [See Section 131.0449(b)]		applies	applies	applies	applies	applies
<i>Parkway Requirement</i> [See Section 131.0452]		applies	applies	applies	applies	applies
<i>Architectural Projections and Encroachments</i> [See Section 131.0461(b)]		applies	applies	applies	applies	applies
Supplemental Requirements [See Section 131.0464(c)]		applies	applies	applies	applies	applies
Refuse and Recyclable Material Storage [See Section 142.0805]		applies	applies	applies	applies	applies

e) RM Zones

**Table 131-04G
Development Regulations for RM Zones**

Development Regulations [See Section 131.0430 for Development Regulations of Residential Zones]	Zone Designator	Zones					
	1st & 2nd >>	RM-					
	3rd >>	1-	1-	1-	2-	2-	2-
	4th >>	1	2	3	4	5	6
Maximum permitted density^{(1),(2)} (sf per DU)		3,000	2,500	2,000	1,750	1,500	1,250
Min lot area (sf)		6,000	6,000	6,000	6,000	6,000	6,000
Min lot dimensions							
Lot width (ft)		50	50	50	50	50	50
Street frontage (ft) [See Section 131.0442(a)]		50	50	50	50	50	50
Lot width (corner) (ft)		55	55	55	55	55	55
Lot depth (ft)		90	90	90	90	90	90
Setback requirements							
Min Front setback (ft)		15 ⁽³⁾	15 ⁽³⁾	15 ⁽³⁾	15 ⁽⁷⁾	15 ⁽⁷⁾	15 ⁽⁷⁾
Std Front Setback (ft)		20 ⁽³⁾	20 ⁽³⁾	20 ⁽³⁾	20 ⁽⁷⁾	20 ⁽⁷⁾	20 ⁽⁷⁾
Min Side setback (ft)		5 ⁽⁴⁾	5 ⁽⁴⁾	5 ⁽⁴⁾	5 ⁽⁸⁾	5 ⁽⁸⁾	5 ⁽⁸⁾
Std Side Setback (ft)		8 ⁽⁴⁾	8 ⁽⁴⁾	8 ⁽⁴⁾	-	-	-
Min Street side setback(ft)		10 ⁽⁵⁾	10 ⁽⁵⁾	10 ⁽⁵⁾	10 ⁽⁹⁾	10 ⁽⁹⁾	10 ⁽⁹⁾
Min Rear setback (ft)		15 ⁽⁶⁾	15 ⁽⁶⁾	15 ⁽⁶⁾	15 ⁽¹⁰⁾	15 ⁽¹⁰⁾	15 ⁽¹⁰⁾
Setback requirements for resubdivided corner lots [See Section 131.0443(i)]		applies	applies	applies	applies	applies	applies
Max structure height (ft)		30 ⁽¹⁷⁾	30 ⁽¹⁷⁾	30 ⁽¹⁷⁾	40 ⁽¹⁸⁾	40 ⁽¹⁸⁾	40 ⁽¹⁸⁾
Max lot coverage		-	-	-	-	-	-
Max floor area ratio		0.75	0.90 ⁽¹⁹⁾	1.05 ⁽¹⁹⁾	1.20 ^(19,29)	1.35 ⁽¹⁹⁾	1.50 ⁽¹⁹⁾
Accessory uses and		applies	applies	applies	applies	applies	applies

Development Regulations [See Section 131.0430 for Development Regulations of Residential Zones]	Zone Designator	Zones					
	1st & 2nd >>	RM-					
	3rd >>	1-	1-	1-	2-	2-	2-
	4th >>	1	2	3	4	5	6
structures [See Section 131.0448]							
Ground-floor Height [See Section 131.0451]	-	-	-	-	-	-	-
Lot consolidation regulations [See Section 131.0453(a)]	applies	applies	-	-	-	-	-
Storage requirements [See Section 131.0454]	applies	applies	applies	applies	applies	applies	applies
Private exterior open space	applies ⁽²²⁾	applies ⁽²²⁾	applies ⁽²²⁾	applies ⁽²³⁾	applies ⁽²³⁾	applies ⁽²³⁾	applies ⁽²³⁾
Common open space [See Section 131.0456]	applies	applies	applies	applies	applies	applies	applies
Architectural projections and encroachments	Permitted ⁽¹⁵⁾	Permitted ⁽¹⁵⁾	Permitted ⁽¹⁵⁾	Permitted ⁽¹⁶⁾	Permitted ⁽¹⁶⁾	Permitted ⁽¹⁶⁾	Permitted ⁽¹⁶⁾
Supplemental requirements	applies ⁽²⁶⁾	applies ⁽²⁶⁾	applies ⁽²⁶⁾	applies ⁽²⁷⁾	applies ⁽²⁷⁾	applies ⁽²⁷⁾	applies ⁽²⁷⁾
Refuse and Recyclable Material Storage [See Section 142.0805]	applies	applies	applies	applies	applies	applies	applies

Development Regulations [See Section 131.0430 for Development Regulations of Residential Zones]	Zone Designator	Zones					
	1st & 2nd >>	RM					
	3rd >>	3-	3-	3-	4-	4-	5
	4th >>	7	8	9	10	11	12
Maximum permitted density^{(1),(2)} (sf per DU)		1,000	800	600	400	200	1,000 ⁽³⁶⁾
Min lot area (sf)		7,000	7,000	7,000	7,000	7,000	10,000
Min lot dimensions							
Lot width (ft)		70	70	70	100	100	100
Street frontage (ft) [See Section 131.0442(a)]		70	70	70	100	100	100
Lot width (corner) (ft)		75	75	75	100	100	100
Lot depth (ft)		100	100	100	100	100	100
Setback requirements							
Min Front setback (ft) Std Front Setback (ft)		10 ⁽¹¹⁾ 20 ⁽¹¹⁾	10 ⁽¹¹⁾ 20 ⁽¹¹⁾	10 ⁽¹¹⁾ 20 ⁽¹¹⁾	varies ⁽¹⁴⁾	varies ⁽¹⁴⁾	15 ⁽³⁰⁾
Min Side setback (ft) Std Side Setback (ft)		5 ⁽¹²⁾ -	5 ⁽¹²⁾ -	5 ⁽¹²⁾ -	varies ⁽¹⁴⁾ -	varies ⁽¹⁴⁾ -	4 ⁽³¹⁾ -
Min Street side setback(ft)		10 ⁽¹³⁾	10 ⁽¹³⁾	10 ⁽¹³⁾	varies ⁽¹⁴⁾	varies ⁽¹⁴⁾	10 ⁽³²⁾
Min Rear setback (ft)		5	5	5	varies ⁽¹⁴⁾	varies ⁽¹⁴⁾	15 ⁽³³⁾
Setback requirements for resubdivided corner lots [See Section 131.0443(i)]		applies	applies	applies	applies	applies	-
Max structure height (ft)		40	50	60	-	-	-
Max lot coverage		-	-	-	applies ⁽²¹⁾	applies ⁽²¹⁾	applies ⁽³⁴⁾
Max floor area ratio		1.80 ⁽²⁰⁾	2.25 ⁽²⁰⁾	2.70 ⁽²⁰⁾	3.60 ⁽²⁰⁾	7.20 ⁽²⁰⁾	1.80 ^{(20),(35)}
Accessory uses and structures [See Section 131.0448]		applies	applies	applies	applies	applies	applies

Development Regulations [See Section 131.0430 for Development Regulations of Residential Zones]	Zone Designator	Zones					
	1st & 2nd >>	RM					
	3rd >>	3-	3-	3-	4-	4-	5
	4th >>	7	8	9	10	11	12
Ground-floor Height [See Section 131.0451]	-	applies	applies	applies	applies	applies	applies
Lot consolidation regulations	-	-	-	-	-	-	-
Storage requirements [See Section 131.0454]	applies	applies	applies	applies	applies	applies	applies
Private exterior open space	Applies ⁽²⁴⁾	applies ⁽²⁴⁾	applies ⁽²⁴⁾	applies ⁽²⁵⁾	applies ⁽²⁵⁾	applies ⁽²⁵⁾	applies ⁽²⁵⁾
Common open space [See Section 131.0456]	applies	applies	applies	applies	applies	applies	applies
Architectural Projections and encroachments	Permitted ⁽¹⁶⁾	Permitted ⁽¹⁶⁾	Permitted ⁽¹⁶⁾	Permitted ⁽¹⁶⁾	Permitted ⁽¹⁶⁾	Permitted ⁽¹⁶⁾	Permitted ⁽¹⁶⁾
Supplemental requirements	Applies ⁽²⁸⁾	applies ⁽²⁸⁾	applies ⁽²⁸⁾	-	-	-	-
Refuse and Recyclable Material Storage [See Section 142.0805]	applies	applies	Applies	applies	applies	applies	Applies

Footnotes for Table 131-04G

- 1 One dwelling unit per specified square foot of lot area as determined in accordance with Section 113.0222.
- 2 An exception to the maximum permitted *density* may be permitted in accordance with Chapter 14, Article 3, Division 7 (Affordable Housing Density Bonus).
- 3 See Section 131.0443(d)(1).
- 4 See Section 131.0443(d)(2).
- 5 See Section 131.0443(d)(3).
- 6 See Section 131.0443(d)(4).
- 7 See Section 131.0443(e)(1).
- 8 See Section 131.0443(e)(2).
- 9 See Section 131.0443(e)(3).
- 10 See Section 131.0443(e)(4).
- 11 See Section 131.0443(f)(1).
- 12 See Section 131.0443(f)(2).
- 13 See Section 131.0443(f)(3).
- 14 See Section 131.0443(g).

- 15 See Section 131.0461(a).
- 16 See Section 131.0461(c).
- 17 See Section 131.0444(e).
- 18 See Section 131.0444(f).
- 19 See Section 131.0446(e).
- 20 See Section 131.0446(f).
- 21 See Section 131.0445(c).
- 22 See Section 131.0455(a).
- 23 See Section 131.0455(b).
- 24 See Section 131.0455(c).
- 25 See Section 131.0455(d).
- 26 See Section 131.0464(d).
- 27 See Section 131.0464(e).
- 28 See Section 131.0464(f).
- 29 With the Peninsula and Ocean Beach community plan areas, the maximum *floor area ratio* is 0.70.
- 30 See Section 131.0443(h)(1).
- 31 See Section 131.0443(h)(2).
- 32 See Section 131.0443(h)(3).
- 33 See Section 131.0443(h)(4).
- 34 See Section 131.0445(d).
- 35 See Section 131.0446(g).
- 36 Within the La Jolla, Pacific Beach, and Torrey Pines community plan areas, the maximum permitted *density* is one dwelling unit or two *guest rooms* for each 1,500 square feet of lot area.

(Added 12-9-1997 by O-18451 N.S.; effective 1-1-2000)

(Amended 6-19-2000 by O-18814 N.S.)

(Amended 8-1-2007 by O-19650 N.S.; effective 8-31-2007.)

(Amended 11-13-08 by O-19805 N.S.; effective 12-13-2008.)

(Amended 11-13-08 by O-19799 N.S.; effective 12-13-2008.)

(Amended 11-13-2008 by O-19801 N.S.; effective 12-13-2008.)

(Amended 8-4-2011 by O-20081 N.S.; effective 10-6-2011.)

(Amended 6-18-2013 by O-20261 N.S.; effective 7-19-2013.)

(Amended 7-10-2015 by O-20512 N.S.; effective 8-9-2015.)

131.0441 Minimum Lot Area in Residential Zones

In the RX and RT zones, *lots* served by *alley* access may use a portion of the *alley* to meet the minimum lot area requirement. Up to one-half the width of the abutting *alley*, not to exceed 10 feet, may be applied toward the total lot area provided the *alley* area does not exceed 10 percent of the minimum lot area requirement.

(Added 12-9-1997 by O-18451 N.S.; effective 1-1-2000.)

§131.0442 Minimum Lot Dimensions in Residential Zones

- (a) Exception to Minimum *Street Frontage* in the RE, RS, and RM Zones

The minimum *street frontage* for any *lot* in the RE, RS, and RM zones that fronts principally on a turnaround or curving *street* with a centerline radius of less than 100 feet, is 60 percent of the *street frontage* specified for the zone in which the *lot* is located as shown in Diagram 131-04A.

**Diagram 131-04A
Lot Frontage on Curving Street**

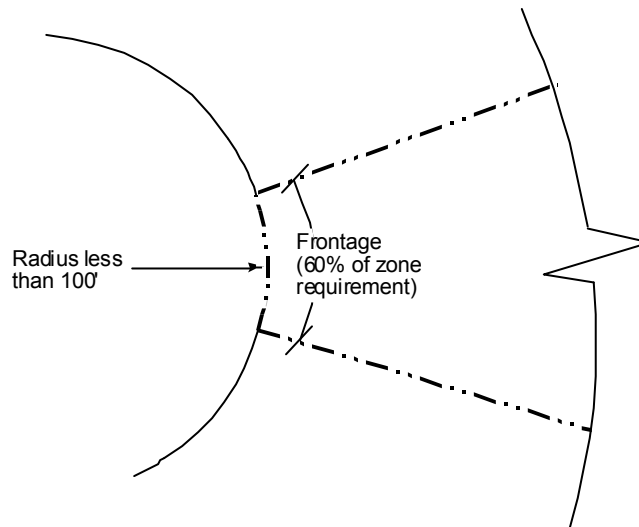

- (b) Exception to Minimum *Street Frontage* in the RX Zones

The minimum *street frontage* is 28.5 feet for any *lot* in the RX zones that fronts principally on a turnaround or curving *street* with a centerline radius of less than 100 feet.

- (c) Minimum Lot Dimensions in the RX-1-2 Zone

Where a *lot* in the RX-1-2 zone abuts an *alley* and access is taken from the *alley*, the indicated minimum lot dimensions are as follows:

Lot Width 25 feet
Street Frontage 25 feet
Lot Width (corner) 25 feet

(Added 12-9-1997 by O-18451 N.S.; effective 1-1-2000.)

§131.0443 Setback Requirements in Residential Zones

(a) *Setbacks* in RE and RS Zones

(1) Front *Setbacks* in RE and RS Zones

For that portion of a *lot* that fronts a cul-de-sac, the minimum front *setback* may be reduced 5 feet below the requirement specified in Tables 131-04C and 131-04D; however, in no case shall the *setback* be less than 5 feet.

(2) Rear *Setback* in all RE Zones and the RS-1-1, RS-1-2, RS-1-3, RS-1-4, RS-1-5, RS-1-6, RS-1-7 Zones

(A) The required rear *setback* is at least the dimension shown in Table 131-04D, except as follows:

(i) For *lots* less than 100 feet in depth, the rear *setback* is at least 10 percent of the lot depth, but not less than 5 feet; and

(ii) For *lots* greater than 150 feet in depth, the rear *setback* is at least 10 percent of the lot depth or the dimension shown in Tables 131-04C and 131-04D, whichever is greater.

(B) Where a rear *yard* abuts an *alley*, one-half of the *alley* width, but not more than 10 feet, may be counted toward the required rear *setback*. In no case shall a rear *setback* using this provision be less than 5 feet on the *premises*. See Diagram 131-04B.

**Diagram 131-04B
Rear Yard Abutting Alley**

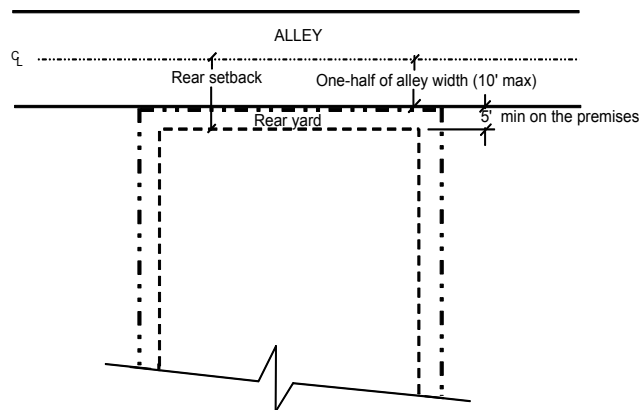

- (C) Where access for parking is taken from the *alley* and the parking spaces are not parallel to the *alley*, a minimum distance of 21 feet shall be provided between the edge of the *alley public right-of-way* opposite the *lot* and the outside edge of the parking garage or parking stall closest to the *alley*. See Diagram 131-04C.

Diagram 131-04C
Parking Adjacent to Alley

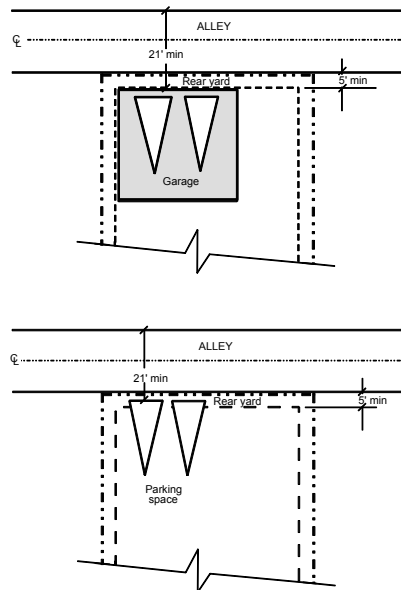

- (3) Rear *Setback* in the RS-1-8, RS-1-9, RS-1-10, RS-1-11, RS-1-12, RS-1-13, and RS-1-14 Zones

For *lots* that are served by *alley* access, the rear *setback* may be reduced to 4 feet.

- (b) *Setbacks* in RX Zones

- (1) Front *Setback* in RX Zones

RX zone *developments* exceeding a total of four dwelling units are required to provide variable front *setbacks* as follows:

- (A) Front *setbacks* of 15 feet are required for at least 25 percent of the total dwelling units, 10-foot front *setbacks* are required for at least 25 percent of the total dwelling units, and 20-foot front *setbacks* are required for at least 25 percent of the total dwelling units;

- (B) No more than 40 percent of the total number of dwelling units are permitted to have front *setbacks* in any one category (i.e. 10 feet, 15 feet, or 20 feet) described in 131.0443(b)(1)(A); and
 - (C) Variable front *setbacks* described in this section shall be established by easement at the time of *tentative map* approval. The easements shall be established at the time of zone application if *lots* are existing and no map is proposed. If a Planned Development Permit is processed, the variable *setbacks* may be established with the permit in lieu of creating easements.
- (2) Side and *Street Side Setbacks* in RX Zones
- (A) For detached dwellings, the following shall apply:
 - (i) Minimum side and *street side setbacks* are at least 3 feet or 10 percent of the lot width, whichever is greater, but is not required to be more than 5 feet;
 - (ii) No side *setback* is required for one side only provided the side with no *setback* is adjacent to other property within an RX zone; and
 - (iii) A separation of at least 10 feet between buildings must be observed on at least one side of each building.
 - (B) For attached dwellings, the following shall apply:
 - (i) No side *setback* shall be observed on one side, excluding street side yard;
 - (ii) The opposite side *setback* is 6 feet or 20 percent of the lot width, whichever is greater, but is not required to be more than 10 feet. This side *setback* may be 4 feet if a vertical offset in the structure's side wall is provided so that a *yard* area within the *building envelope* is provided that is equal to or exceeds the area projecting into the required *yard*. See Diagram 131-04D.

Diagram 131-04D
Side Yard Offset in the RX Zones

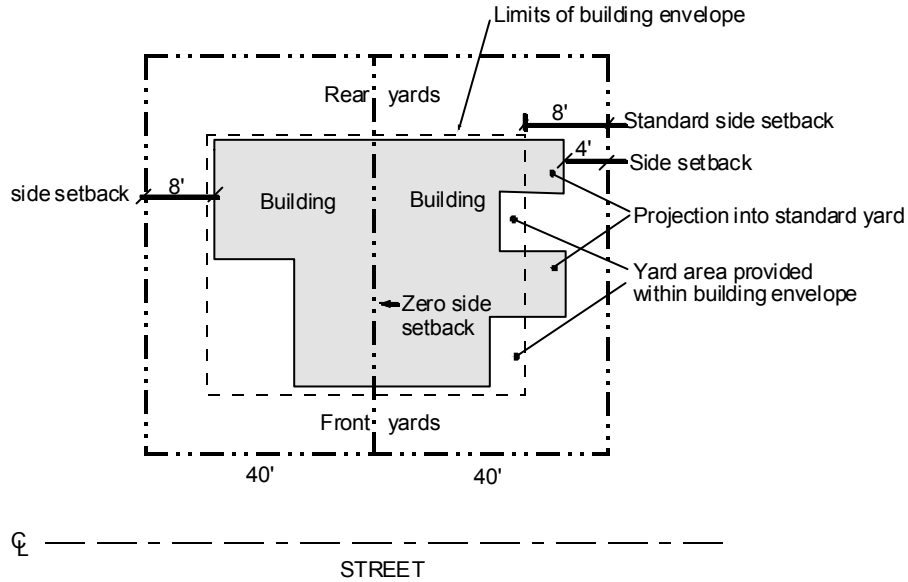

- (iii) Each separate dwelling unit shall have its own side *yard* wall construction that may abut another *dwelling unit* at the common property line. Common wall construction between two *dwelling units* is not permitted.
- (3) Rear *Setback* in RX Zones
Rear *setbacks* shall be at least 10 feet or, if *alley* access exists, at least 4 feet.
- (c) *Setbacks* in RT Zones
 - (1) Front *Setback* in RT Zones
 - (A) The minimum front *setback* is 10 percent of the depth of the *lot*, and in no case shall be less than 5 feet or more than 15 feet. At least some portion of the *building facade* shall be located within 1 foot of the *setback line*.
 - (B) 50 percent of the front *building facade* may encroach into the required front *yard* in accordance with Section 131.0461(b) provided that all supplemental requirements are met as set forth in Section 131.0464(c).

- (2) Side *Setbacks* in RT Zones
 - (A) Side *yards* are not permitted except for lightwells and *court yards*, as shown in Diagram 131-04E, which shall be a minimum of 6 feet by 10 feet.

Diagram 131-04E
Lightwells and Courtyards in the RT Zones

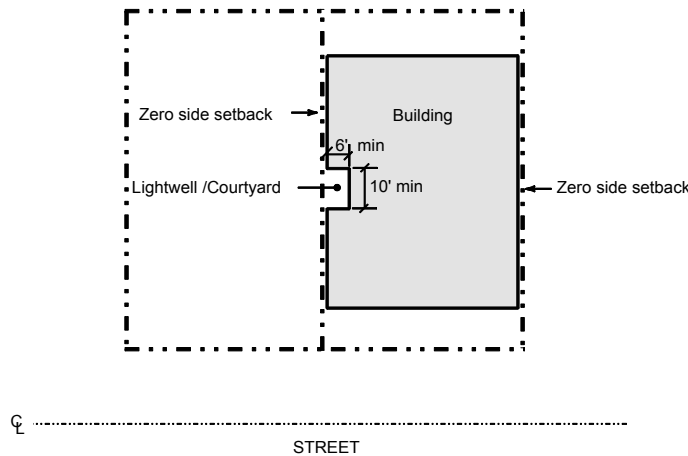

- (B) Each separate dwelling unit shall have its own side yard wall construction that may abut another *dwelling unit* at the common property line. Common wall construction between two *dwelling units* is not permitted.
 - (C) A minimum side *setback* of 3 feet is required adjacent to any *lot* that is not within an RT zone.
 - (D) Windows or doors adjacent to side *setbacks* are only permitted when the distance between the window or door and the *property line* is a minimum of 5 feet or when the side *setback* is a *street side yard*.
- (d) *Setbacks* in RM-1-1, RM-1-2, RM-1-3 Zones
 - (1) Front *Setback* in RM-1-1, RM-1-2, RM-1-3 Zones

- (A) Up to 50 percent of the width of the *building envelope* may observe the minimum 15-foot front *setback*, provided the remaining percentage of the *building envelope* width observes the standard 20-foot *setback*. This may occur on a *floor-by-floor* basis. See Diagram 131-04F.

Diagram 131-04F
Standard/Minimum Front Setback

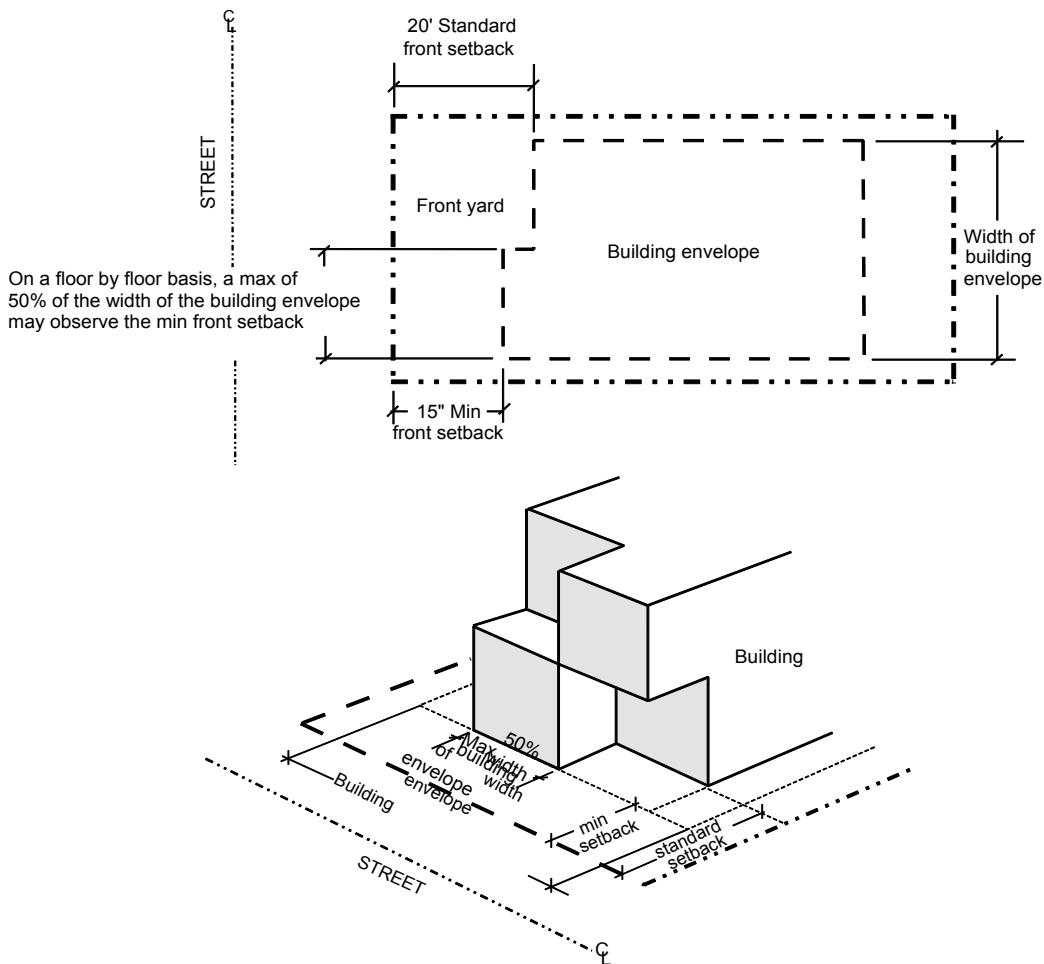

- (B) For any portion of a *lot* that fronts on a curving *street* with a centerline radius of less than 100 feet, the standard *setback* is 10 feet, and the minimum *setback* is 5 feet.

(2) Side Setbacks in RM-1-1, RM-1-2, RM-1-3 Zones

- (A) Up to 50 percent of the length of the *building envelope* on one side of the *premises* may observe the minimum 5-foot side *setback*, provided the remaining percentage of the *building envelope* length observes at least the standard side *setback* of 8 feet or 10 percent of the lot width, whichever is greater.

One hundred percent of the length of the *building envelope* on the opposite side may observe the minimum side *setback* of 5 feet. See Diagram 131-04G.

Diagram 131-04G
Standard/Minimum Side Setback

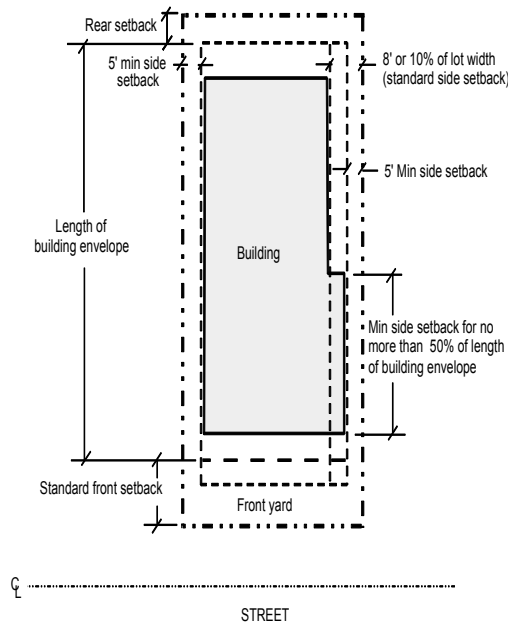

- (B) Exception: The minimum and standard side *setbacks* are at least 4 feet for a *premises* that is less than 50 feet but more than 25 feet wide. The minimum and standard side *setbacks* are at least 3 feet for a *premises* that is 25 feet wide or less.
- (C) Where there is an existing *development* on the *premises* with the side *setback* less than the current requirement and the building is to be maintained, new *development* may observe the existing side *setback* for 50 percent of the length of the *building envelope* on a *floor-by-floor* basis.

- (3) *Street Side Setback* in RM-1-1, RM-1-2, RM-1-3 Zones
The minimum *street side setback* is at least 10 feet or 10 percent of the *premises* width, whichever is greater.
 - (4) *Rear Setback* in RM-1-1, RM-1-2, RM-1-3 Zones
Where a rear *yard* abuts an *alley*, one-half of the *alley* width, but not more than 10 feet, may be counted toward the required rear *yard*. In no case shall a rear *setback* using this provision be less than 5 feet.
- (e) *Setbacks* in RM-2-4, RM-2-5, RM-2-6 Zones
- (1) *Front Setback* in RM-2-4, RM-2-5, RM-2-6 Zones
 - (A) Up to 50 percent of the width of the *building envelope* may observe the minimum 15-foot front *setback*, provided the remaining percentage of the *building envelope* width observes the standard 20-foot *setback*. This may occur on a *floor-by-floor* basis.
 - (B) For any portion of a *lot* that fronts on a curving *street* with a centerline radius of less than 100 feet, the standard front *setback* is 10 feet and the minimum *setback* is 5 feet.
 - (2) *Side Setbacks* in RM-2-4, RM-2-5, RM-2-6 Zones
 - (A) The minimum side *setback* is 5 feet or 10 percent of the *premises* width, whichever is greater.
 - (B) Exception: The minimum side *setback* is 4 feet for a *premises* that is 40 to 50 feet in width.
 - (C) For *lots* with less than 40 feet in width, each side *setback* may be reduced to 10 percent of the *lot* width but shall not be reduced to less than 3 feet.
 - (3) *Street Side Setback* in RM-2-4, RM-2-5, RM-2-6 Zones
 - (A) The minimum *street side setback* is 10 feet or 10 percent of the *premises* width, whichever is greater.
 - (B) *Street Side Yard Encroachment Option*. Up to 50 percent of the *building facade* may encroach up to 5 feet into the required street side yard. The *encroachment* may occur on a *floor-by-floor* basis. See Diagram 131-04H.

**Diagram 131-04H
Street Side Yard Encroachment Option**

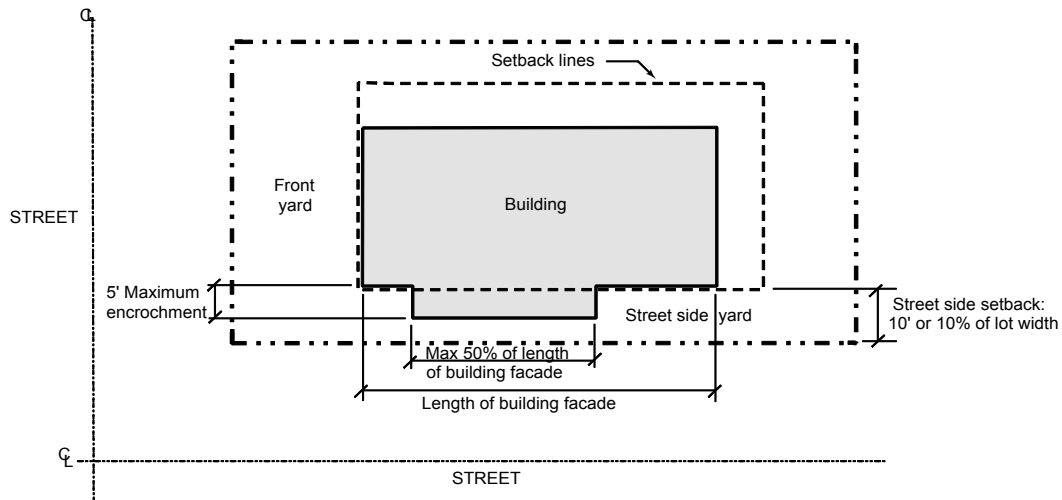

(4) Rear *Setback* in RM-2-4, RM-2-5, RM-2-6 Zones

Where a rear yard abuts an *alley*, one-half of the *alley* width, but not more than 10 feet, may be counted toward the required rear *yard*. In no case shall a rear *setback* using this provision be less than 5 feet.

(f) *Setbacks* in RM-3-7, RM-3-8, RM-3-9 Zones

(1) Front *Setback* in RM-3-7, RM-3-8, RM-3-9 Zones

(A) Up to 50 percent of the width of the *building envelope* may observe the minimum 10-foot front *setback*, provided the remaining percentage of the *building envelope* width observes the standard 20-foot *setback*. This may occur on a *floor-by-floor* basis.

(B) For any portion of a *lot* that fronts on a curving *street* with a centerline radius of less than 100 feet, the standard front *setback* is 10 feet and the minimum *setback* is 5 feet.

(2) Side *Setbacks* in RM-3-7, RM-3-8, RM-3-9 Zones

(A) The minimum side *setback* is 5 feet or 10 percent of the *premises* width, whichever is greater.

(B) Up to 50 percent of the length of the building adjacent to the side *yard* may abut the side *property line*, provided that no encroaching element shall exceed 30 feet in length, that encroaching elements are separated by at least 6 feet, and that each dwelling unit has access to either the front or rear of the *lot*. See Diagram 131-04I.

Diagram 131-04I
Zero Side Setback Option

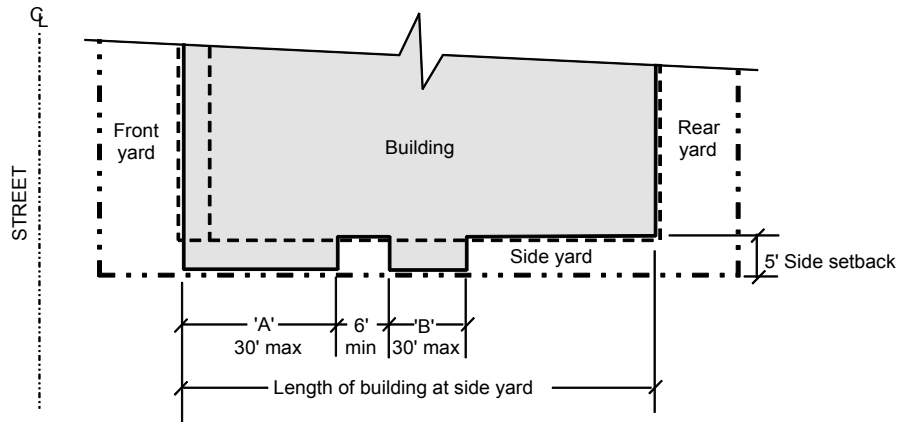

NOTE: The total length of 'A' plus 'B' shall not exceed 50% of the length of the building at side yard.

- (3) *Street Side Setback* in RM-3-7, RM-3-8, RM-3-9 Zones
 - (A) The minimum *street side setback* is 10 feet or 10 percent of the *premises* width, whichever is greater.
 - (B) Up to 50 percent of the *building facade* may encroach up to 5 feet into the required street side yard.
- (g) *Setbacks* in RM-4-10, RM-4-11 Zones
 - (1) Two contiguous *yards* must observe *setbacks* of at least 15 feet on the northerly and easterly elevations, as shown in Diagram 131-04J.

Diagram 131-04J
Contiguous Yard Requirement

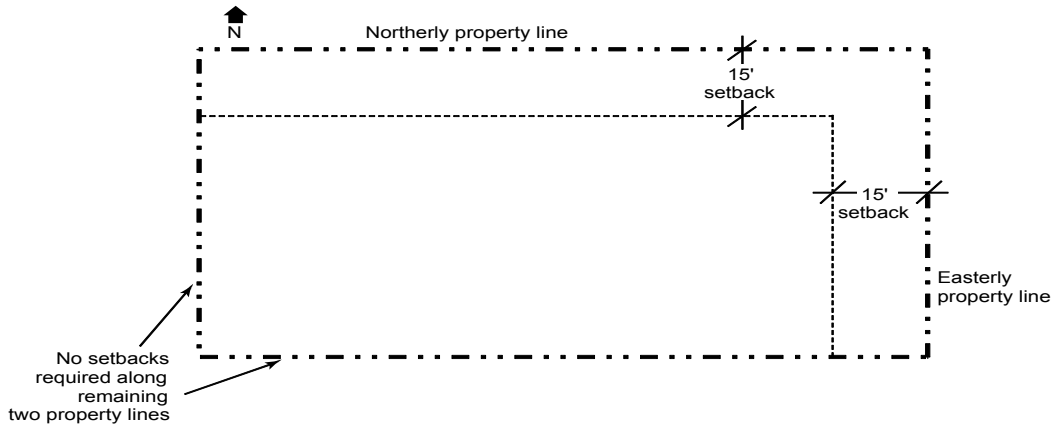

- (2) The side *yard* and rear *yard* shall equal the requirements of the adjacent residential zone if that zone is more restrictive.

- (h) *Setback* Requirements in the RM-5-12 Zone
 - (1) *Front Setback* in the RM-5-12 Zone

The minimum front *setback* is 10 feet for any portion of a *lot* that fronts on a turnaround or on a curving *street* with a centerline radius of less than 100 feet.
 - (2) *Side Setback* in the RM-5-12 Zone

The minimum side *setback* specified in Table 131-04G shall be increased 3 feet for each 12 feet of *structure height* over 24 feet.
 - (3) *Street Side Setback* in the RM-5-12 Zone

The minimum *street side setback* is as indicated in Table 131-04G, except as follows:

 - (A) 9 feet for any *lot* that is at least 45 but less than 50 feet wide;
 - (B) 8 feet for any *lot* that is at least 40 but less than 45 feet wide;
 - (C) 7 feet for any *lot* that is at least 35 but less than 40 feet wide;
 - (D) 6 feet for any *lot* that is at least 30 but less than 35 feet wide; and
 - (E) 5 feet for any *lot* that is less than 30 feet wide.

(4) Rear *Setback* in the RM-5-12 Zone

The rear *setback* specified in Table 131-04G shall be increased 3 feet for each 12 feet of *structure height* over 24 feet.

(Amended 6-12-2001 by O-18948 N.S.; effective 12-12-2001.)
(Amended 11-28-2005 by O-19444 N.S.; effective 2-9-2006.)
(Amended 3-1-2006 by O-19468 N.S.; effective 4-1-2006.)
(Amended 11-13-2008 by O-19801 N.S.; effective 12-13-2008.)
(Amended 8-4-2011 by O-20081 N.S.; effective 10-6-2011.)
(Amended 6-18-2013 by O-20261 N.S.; effective 7-19-2013.)
(Amended 7-2-2013 by O-20268 N.S.; effective 8-2-2013.)
(Amended 7-10-2015 by O-20512 N.S.; effective 8-9-2015.)

§131.0444 Angled Building Envelope Plane / Maximum Structure Height in Residential Zones

- (a) Maximum *structure height* shall not exceed the height of the angled *building envelope* plane, which connects the maximum *structure height* adjacent to the setback and the overall maximum *structure height* as determined by the underlying base zone and the requirements below. Encroachments beyond the *building envelope* are subject to the requirements in Section 131.0461.
- (b) The angle of the *building envelope* plane is based on lot width as established in Table 131-04H.

Table 131-04H

Required Angle Building Envelope Plane

Lot Width:	Angle of Plane ¹
Less than 75 feet	45 degrees
75 feet to 150 feet	30 degrees
Greater than 150 feet	Not Applicable

Footnote for Table 131-04H

¹ The angled planes are measured from the vertical axis inward.

- (c) The maximum *structure height* requirements for the RS-1-1, RS-1-2, RS-1-3, RS-1-4, RS-1-5, RS-1-6, RS-1-7, and RX zones are stated in Tables 131-04D and 131-04E. The angled *building envelope* plane shall be required adjacent to required side *yards*. Angled *building envelope* planes are also required adjacent to front and street side *yards* in cases where the maximum *structure height* exceeds 27 feet. The angled *building envelope* plane shall be measured in accordance with Diagram 131-04L.

Diagram 131-04L
Angled Building Envelope Planes in RS, RX, and RT Zones

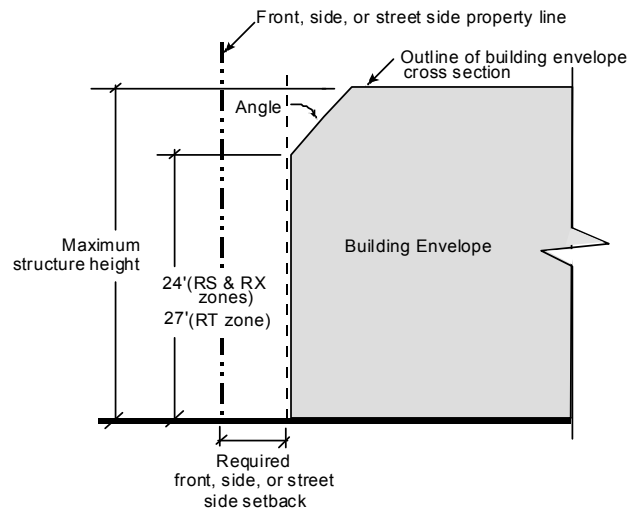

- (d) The maximum *structure height* requirements for RT zones are stated in Table 131-04F. For buildings with a slab foundation, the maximum permitted *structure height* is 21 feet for one- and two-story *structures* or 31 feet for three-story *structures*. For buildings with a conventional raised floor, the maximum permitted *structure height* is 25 feet for one- and two-story *structures* or 35 feet for three-story *structures*. For buildings with sloped roofs with at least a 3:12 pitch (3 vertical feet to 12 horizontal feet), the maximum permitted *structure height* is increased by 5 feet. In all cases, unless otherwise excepted, the height of the *building envelope* above 27 feet adjacent to the front *setback line* is established by a 30-degree angled *building envelope* plane slanting inward to the maximum permitted *structure height*. The angled *building envelope* planes shall be measured in accordance with Diagram 131-04L.
- (e) The maximum *structure height* requirements for the RM-1-1, RM-1-2, and RM-1-3 zones are stated in Table 131-04G. The angled *building envelope* plane requirements apply as follows:
- (1) At the front *setback line*, the height of the *building envelope* above 19 feet at the minimum *setback* and 24 feet at the standard *setback*, is established by a 45-degree angled *building envelope* plan sloping inward to the maximum permitted 30-foot *structure height* limit, as shown in Diagram 131-04M.

§131.0445 Lot Coverage in Residential Zones

- (a) In all RE zones, the RS-1-1, RS-1-2, RS-1-3, RS-1-4, RS-1-5, RS-1-6, and RS-1-7 zones, and in small *lot subdivisions* in accordance with Section 143.0365, the maximum permitted *lot coverage* is 50 percent on any *premises* where more than 50 percent of the *premises* contains *steep hillsides*.
- (b) In the RT zones, garages of 525 square feet of *floor* area or less are not included in the calculation of *lot coverage*. Bay windows and turrets, when built at ground level, count as coverage. Roofed entryways (porches) and balconies with at least two elevations that are a minimum of 40 percent open do not count as coverage.
- (c) In the RM-4-10 and RM-4-11 zones, maximum *lot coverage* is 50 percent for interior *lots* and 60 percent for corner *lots*.
- (d) In the RM-5-12 zone, maximum *lot coverage* is 50 percent for interior *lots* and 60 percent for corner *lots*, except that maximum *lot coverage* for any *premises* that has a building exceeding 4 *stories* or 48 feet in *height* shall be reduced in accordance with Table 131-04I.

Table 131-04I

Lot Coverage in RM-5-12 Zone

<i>Stories or Structure Height</i>	<i>Maximum Lot Coverage</i>
1-4 <i>stories</i> or 48 feet	50/60%
5 <i>stories</i> or 60 feet	37%
6 <i>stories</i> or 72 feet	32%
7 <i>stories</i> or 84 feet	28%
8 <i>stories</i> or 96 feet	25%
9 <i>stories</i> or 108 feet	23%
More than 10 <i>stories</i> or 120 feet	21%

*(Added 12-9-1997 by O-18451 N.S.)
(Amended 10-18-1999 by O-18691 N.S.; effective 1-1-2000.)
(Amended 5-5-2015 by O-20483 N.S.; effective 6-4-2015.)*

§131.0446 Maximum Floor Area Ratio in Residential Zones

- (a) *Floor Area Ratio* for the RS-1-2, RS-1-3, RS-1-4, RS-1-5, RS-1-6, RS-1-7 Zones
 - (1) The maximum permitted *floor area ratio* is based on the lot area in accordance with Table 131-04J:

Table 131-04J
Maximum *Floor Area Ratio* in RS-1-2, RS-1-3, RS-1-4, RS-1-5, RS-1-6, RS-1-7 Zones

Lot Area (square feet)	<i>Floor Area Ratio</i>
3,000 and less	0.70
3,001 - 4,000	0.65
4,001 - 5,000	0.60
5,001 - 6,000	0.59
6,001 - 7,000	0.58
7,001 - 8,000	0.57
8,001 - 9,000	0.56
9,001 - 10,000	0.55
10,001 - 11,000	0.54
11,001 - 12,000	0.53
12,001 - 13,000	0.52
13,001 - 14,000	0.51
14,001 - 15,000	0.50
15,001 - 16,000	0.49
16,001 - 17,000	0.48
17,001 - 18,000	0.47
18,001 - 19,000	0.46
19,001 and greater	0.45

- (2) For *lots* that exceed the minimum *lot* area required by the applicable zone and where more than 50 percent of the *lot* area contains *steep hillsides*, the maximum permitted *floor area ratio* shall be based on the following:
- (A) The area of the site not containing *steep hillsides* or the minimum *lot* area required by the applicable zone, whichever is greater; plus
 - (B) 25 percent of the remaining *lot* area not included in (A), above.

- (b) In the RS-1-8, RS-1-9, RS-1-10, RS-1-11, RS-1-12, RS-1-13, and RS-1-14 zones, up to 400 square feet of garage area shall be excluded from the calculation of *gross floor area*.
- (c) In the RX zone, the calculation of *floor area ratio* shall be based on the minimum *lot* area of the zone, or the area of the *lot* with a gradient less than 10 percent, whichever is greater.
- (d) In the RT zones, up to 525 square feet of garage area may be excluded from the calculation of *gross floor area*.
- (e) In the RM-1-2, RM-1-3, RM-2-4, RM-2-5, and RM-2-6 zones, a minimum of one-fourth of the permitted *floor area ratio* shall be reserved for required parking. The maximum *floor area ratio* for all *structures* on the *premises*, excluding underground parking *structures*, shall not exceed the maximum permitted *floor area ratio* for the zone as identified in Table 131-04G, except that a *floor area ratio* bonus shall be provided equal to the *gross floor area* of the underground parking *structure*.
- (f) In the RM-3-7, RM-3-8, RM-3-9, RM-4-10, RM-4-11, and RM-5-12 zones, a minimum of one-third of the permitted *floor area ratio* shall be reserved for required parking. The maximum *floor area ratio* for all *structures* on the *premises*, excluding underground parking *structures*, shall not exceed the maximum permitted *floor area ratio* for the zone as identified in Table 131-04G, except that a *floor area ratio* bonus shall be provided equal to the *gross floor area* of the underground parking *structure*.
- (g) In the RM-5-12 zone, the maximum permitted *floor area ratio* for buildings exceeding 4 *stories* or 48 feet of *structure height* shall be increased in accordance with Table 131-04K.

Table 131-04K
Floor Area Ratio in the RM-5-12 Zone

<i>Stories or Structure Height</i>	<i>Maximum Floor Area Ratio</i>
1-4 stories or 48 feet	1.80
5 stories or 60 feet	1.85
6 stories or 72 feet	1.90
7 stories or 84 feet	1.95
8 stories or 96 feet	2.00
9 stories or 108 feet	2.05
More than 10 stories or 120 feet	2.10

(Added 12-9-1997 by O-18451 N.S.; effective 1-1-2000.)

(Amended 8-4-2011 by O-20081 N.S.; effective 10-6-2011.)

(Amended 7-10-2015 by O-20512 N.S.; effective 8-9-2015.)

§131.0447 Maximum Paving and Hardscape in Residential Zones

Paving and *hardscape* on *single dwelling unit* lots located in the RS zones shall be minimized as follows:

- (a) The required front *yard* shall be limited to a maximum of 60 percent paving and *hardscape*.
- (b) Within the required *street yard* paving and *hardscape* shall be limited to:
 - (1) A driveway with direct vehicular access to required *off-street parking spaces* located outside of the required *setback* in accordance with section 142.0521,
 - (2) A walkway to facilitate pedestrian access to the *dwelling unit*, and
 - (3) Any decorative paving or *hardscape* that is not designed for vehicular access.
- (c) In order to maintain the character of the RS zone, paving and *hardscape* for vehicular use on *lots* less than 10,000 square feet, shall be further limited to off-street, surface parking for a maximum of 4 vehicles. Additional paving and *hardscape* shall be permitted for non-vehicular use or where necessary to provide vehicular access to garage parking.

(Added 12-9-1997 by O-18451 N.S.; effective 1-1-2000.)

(Amended 08-1-2007 by O-19650 N.S.; effective 08-31-2007.)

§131.0448 Accessory Buildings in Residential Zones

This section is intended to clarify the regulations applicable to non-habitable *accessory buildings* in residential zones.

- (a) Multiple *accessory buildings* are permitted on a *premises*. However, the square footage of all non-habitable *accessory buildings* excluding garages cannot exceed 25 percent of the allowable *gross floor area* of the *premises*.
- (b) Non-habitable *accessory buildings* or garages may not be used for living or sleeping purposes. A non-habitable *accessory building* or garage may have electrical, gas, water, and sewer connections to provide the following activities:
 - (1) Lighting, washing machines, dryers, laundry tubs, and hot water heater;
 - (2) A one-half bathroom, limited to a water closet and a lavatory sink; and

- (3) A shower, provided the property owner signs an agreement recorded with the County Recorder and processed through the City Manager stating that the building will not be used for living or sleeping purposes.
- (c) Non-habitable *accessory buildings* or garages may encroach into required *yards* subject to the requirements in Section 131.0461.
- (d) Habitable *accessory buildings* may be permitted as follows:
 - (1) As an *accessory building* to a *single dwelling unit* in accordance with Sections 141.0302 or 141.0306; or
 - (2) As an *accessory building* to a *multiple dwelling unit development* to provide common area facilities for the property owners, tenants, and their guests in accordance with the underlying base zone.

(Retitled from “Accessory Uses and Structures in Residential Zones” and amended 1-9-2001 by O-18910 N.S.; effective 8-8-2001.)
(Amended 3-01-2006 by O-19467 N.S.; effective 8-10-2006.)
(Amended 11-13-2008 by O-19801 N.S.; effective 12-13-2008.)
(Retitled from “Accessory Structures in Residential Zones” to “Accessory Buildings in Residential Zone and amended 8-4-2011 by O-20081 N.S.; effective 10-6-2011.)
(Amended 5-5-2015 by O-20481 N.S.; effective 6-4-2015.)

§131.0449 Garage Regulations in Residential Zones

- (a) Garages within an existing embankment in the RE, RS, and RX Zones, and in small *lot subdivisions* in accordance with Section 143.0365.

Attached or detached garages, not exceeding 12 feet in height, including parapets and handrails, may encroach into the front and *street side yards*, as shown in Diagram 131-04N, subject to the following conditions:

- (1) The building is used only for required parking and incidental storage related to residential use;
- (2) The building is located entirely within a pre-existing embankment at least 6 feet high, which shall be maintained. The embankment must have an average height of at least 6 feet within the area where the building is proposed.
- (3) The *building facade* is set back a minimum of 6 feet from the *property line*;
- (4) The building elevation facing the *street* is no more than 24 feet wide;
- (5) No garage door opens so that it projects into the *public right-of-way* at any time;
- (6) In the RE and RS zones the building does not exceed 525 square feet in *gross floor area*;
- (7) In the RX zone the building does not exceed 400 square feet in *gross floor area*; and
- (8) If the building is constructed in conjunction with a *retaining wall* that will be located within the required front *yard*, the *retaining wall* must be flared outward from the corners of the building at a minimum 45-degree angle to provide a *visibility area*.

Diagram 131-04N
Garage Within Existing Embankment

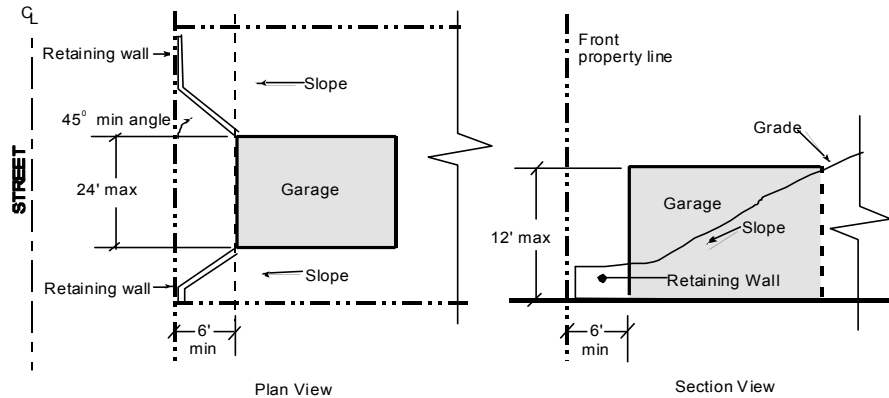

(b) Garages in RT Zones

- (1) Two *off-street parking spaces* are required. An enclosed and detached one-car garage is required except as otherwise provided in this section. The second *off-street parking* may be provided in an enclosed and detached garage or an unenclosed space located consistent with the garage location requirements in Section 131.0449(b)(5).
- (2) Notwithstanding Chapter 13, Article 2, Division 9 (Residential Tandem Parking Overlay Zone), a two-car garage may provide parking in tandem spaces.
- (3) Access to required parking shall be from an *alley* abutting the *premises*. In lieu of public *alleys* in new *subdivisions*, private easements may be used to provide access for abutting residents and authorized service vehicles only.
- (4) The garage shall provide at least one 9-foot by 20-foot *off-street-parking space* perpendicular to, and directly accessible from, the abutting *alley*.
- (5) The garage shall be located within the rear 30 feet of the *lot*, except to the extent that it is necessary to accommodate a 21-foot distance between the edge of the garage and the edge of the *alley* opposite the *lot*.

- (6) The detached garage shall not exceed 12 feet in height.
- (7) The garage may have a *roof deck* with open or solid safety fencing not to exceed 42 inches in height.
- (8) The garage shall abut one interior *property line*.
- (9) The garage may be attached to the *dwelling unit*, subject to the following conditions:
 - (A) A court yard with minimum dimensions of 10 feet by 10 feet must be provided within the rear 50 percent of the *lot*, as shown in Diagram 131-04O, or within the dwelling unit. The court yard shall extend the full height of the *structure* and must be at least 75 percent open to sunlight;

Diagram 131-04O
Courtyard Requirement with Attached Garage

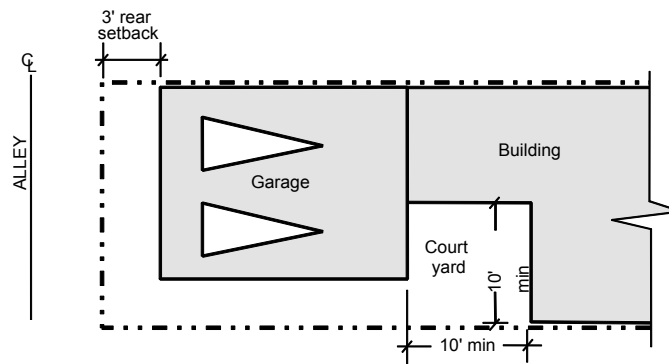

- (B) The vehicle entry facade of the garage may not be more than 24 feet from the rear *property line*; and
 - (C) The garage is subject to the same height limits as the dwelling unit.
- (10) Habitable space may be located above an attached garage.

(Added 12-9-1997 by O-18451 N.S.; effective 1-1-2000; amended 6-19-2000 by O-18814 N.S.)
(Amended 11-13-2008 by O-19801 N.S.; effective 12-13-2008.)
(Amended 5-5-2015 by O-20483 N.S.; effective 6-4-2015)
(Amended 7-10-2015 by O-20512 N.S.; effective 8-9-2015.)

§131.0450 Building Spacing in Residential Zones

Detached dwellings shall maintain a minimum distance of 6 feet between dwellings and 3 feet between any dwelling and any detached, nonhabitable accessory building located on the same *premises*.

(Added 12-9-1997 by O-18451 N.S.; effective 1-1-2000.)

§131.0451 Ground-floor Height

Ground-floor height requirements apply to *structures* with commercial uses on the ground floor. The minimum ground-floor height for *structures* shall be the average of 15 feet, but shall not be less than 13 feet, measured from the average *grade* of the adjoining sidewalk, in increments of no more than 100 feet along a *development* frontage, to the finished elevation of the second floor.

(Added 12-9-1997 by O-18451 N.S.; effective 1-1-2000.)

(Amended 7-10-2015 by O-20512 N.S.; effective 8-9-2015.)

§131.0452 Parkway Requirement in the RT Zones

Subdivisions within the RT zones shall include a landscaped *parkway* between the *street* and the parallel public sidewalk that is at least 4 feet, 6 inches wide.

(Added 12-9-1997 by O-18451 N.S.; effective 1-1-2000.)

§131.0453 Lot Consolidation Regulations in the RM-1-1 and RM-1-2 Zones

In the RM-1-1 and RM-1-2 zones within urbanized communities, *lot* consolidation is subject to the following:

- (a) Any building on a consolidated *premises* may cross only one previous *property line*, as shown in Diagram 131-04P;
- (b) If the consolidation results in a total *street frontage* exceeding 60 feet, the number of dwelling units permitted within any single building shall not exceed the number of units that would have been permitted on the largest *premises* before the consolidation, as shown in Diagram 131-04P;

Diagram 131-04P

Buildings on Consolidated Lots

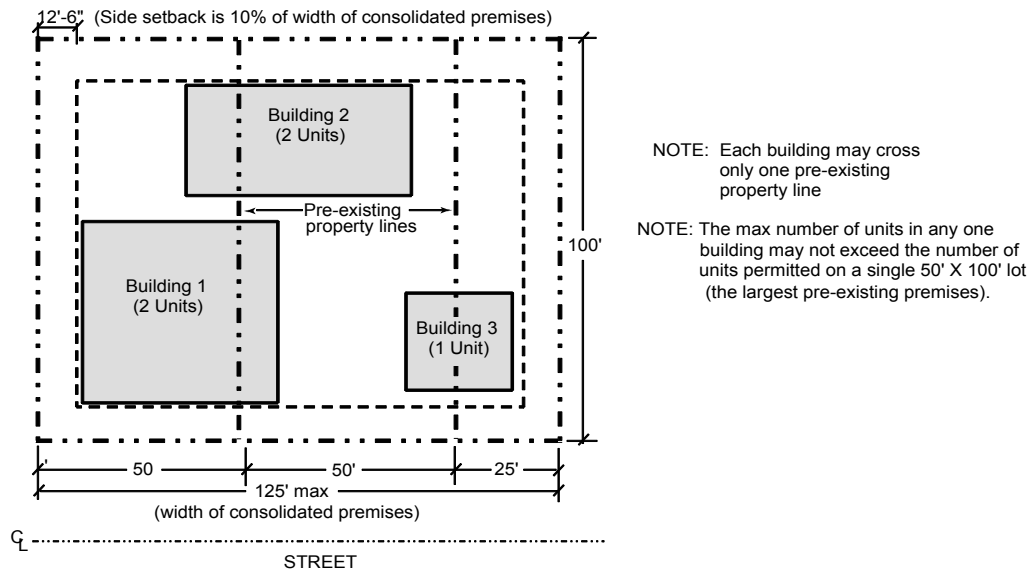

- (c) If the depth of the *lots* to be consolidated is greater than 139 feet, only 139 feet shall be used in the calculation to determine the number of units permitted without a Site Development Permit; and

- (d) Within the front 50 percent of the consolidated *premises*, a minimum 3-foot offset in the front facade shall be required for any building where the dimension most parallel to the *street* exceeds one-and-one-half times the width of the permitted *building envelope* of the largest *lot* existing before consolidation. See Diagram 131-04Q.

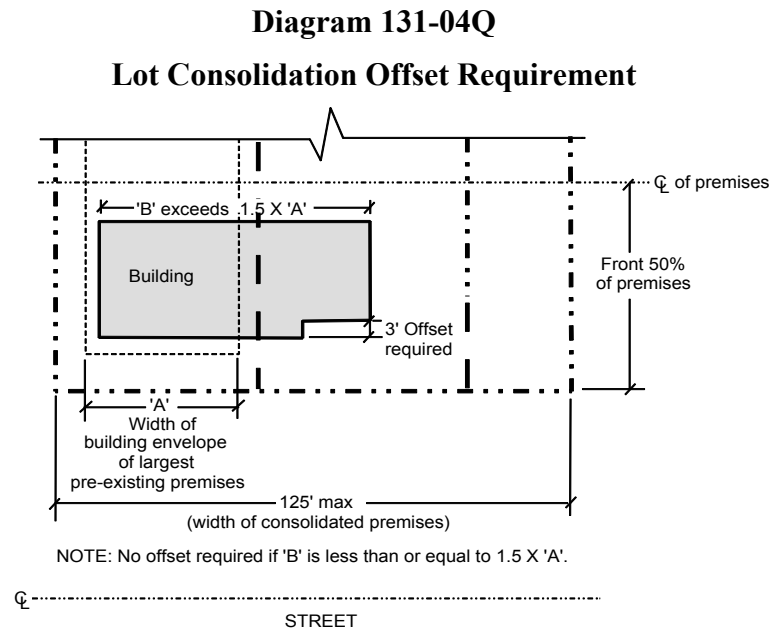

(Added 12-9-1997 by O-18451 N.S.; effective 1-1-2000.)
(Amended 11-13-2008 by O-19801 N.S.; effective 12-13-2008.)

§131.0454 Storage Requirements in the RM Zones

In all RM zones, each dwelling unit shall have a fully enclosed, personal storage area outside the unit that is at least 240 cubic feet with a minimum 7-foot horizontal dimension along one plane.

(Added 12-9-1997 by O-18451 N.S.; effective 1-1-2000.)

§131.0455 Private Exterior Open Space in the RM Zones

- (a) In the RM-1-1, RM-1-2, and RM-1-3 zones, at least 60 square feet of usable, private, exterior open space abutting each dwelling unit shall be provided with a minimum dimension of 6 feet in any direction. The open space may be located in required *yard* areas, but shall be no closer than 9 feet to the front or rear *property lines*, and no closer than 4 feet to the side *property lines*. See Diagram 131-04R.

Diagram 131-04R
Private Exterior Open Space

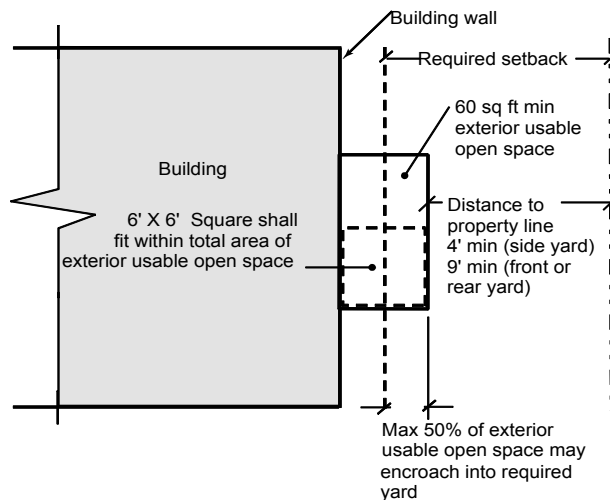

- (b) In the RM-2-4, RM-2-5, and RM-2-6 zones, at least 75 percent of the dwelling units shall be provided with at least 60 square feet of usable, private, exterior open space abutting the unit with a minimum dimension of 6 feet. The open space may be located in required front and rear *yards*, but shall be no closer than 9 feet to the front *property line*.
- (c) In the RM-3-7, RM-3-8, and RM-3-9 zones, at least 75 percent of the dwelling units shall be provided with at least 60 square feet of usable, private, exterior open space abutting the unit with a minimum dimension of 6 feet. The open space may be located in the required front *yard*, but shall be no closer than 9 feet to the front *property line*.
- (d) In the RM-4-10, RM-4-11, and RM-5-12 zones, at least 50 square feet of usable, private, exterior open space abutting each dwelling unit shall be provided with a minimum dimension of 4 feet.

(Added 12-9-1997 by O-18451 N.S.; effective 1-1-2000.)

(Amended 11-13-2008 by O-19801 N.S.; effective 12-13-2008.)

§131.0456 Common Open Space in the RM Zones

In all RM zones, *premises* with more than four dwelling units shall include common open space as follows:

- (a) The common open space area shall be at least 300 square feet, or 25 square feet per dwelling unit, whichever is greater.
- (b) At least one area of common open space shall be provided with minimum dimensions of 12 feet by 15 feet. This space shall be improved as a usable area with lawn or recreational facilities.
- (c) Roofed *structures* may occupy a maximum of 50 percent of the common open space area. No enclosed buildings are permitted in the common open space area.
- (d) Common open space may be provided in the required side and rear *yards*.
- (e) Common open space shall be landscaped or improved with outdoor recreational facilities available only to the residents and guests of the *development*.

(Added 12-9-1997 by O-18451 N.S.; effective 1-1-2000.)

§131.0460 Maximum Third Story Dimensions in the RS Zones and in Small Lot Subdivisions

In the RS-1-2, RS-1-3, RS-1-4, RS-1-5, RS-1-6, and RS-1-7 zones, and in small *lot subdivisions* in accordance with Section 143.0365, the following shall apply:

- (a) The width of the third *story* is limited to 70 percent of the width of the *lot*.
- (b) The depth of the third *story* is limited to 50 percent of the depth of the *lot* or 100 percent of the maximum width dimension, whichever is greater.

(Added 12-9-1997 by O-18451 N.S.; effective 1-1-2000.)

(Retitled to "Maximum Third Story Dimensions in the RS Zones and in Small Lot Subdivisions" and amended 5-5-2015 by O-20483 N.S.; effective 6-4-2015.)

§131.0461 Architectural Projections and Encroachments in Residential Zones

- (a) The following are permitted *architectural projections* and *encroachments* into required *yards* and the angled *building envelope* plane for RS and RX zones, the RM-1-1, RM-1-2, and RM-1-3 zones, and in small *lot subdivisions* in accordance with Section 143.0365. These projections and *encroachments* are not permitted in the required *yards* within view corridors that are designated by *land use plans* in the Coastal Overlay Zone and may not be located in a required *visibility area* or a required turning radius or vehicle back-up area except where *development* regulations may allow.
 - (1) Roof projections such as eave, cornice, and eyebrow projections may extend into the required *yard* or into the space above the angled *building envelope* subject to the following:
 - (A) The projection may extend a maximum of 6 feet into the required *yard* or 50 percent of the width of the required *yard*, whichever is less;
 - (B) The projection shall not be closer than 2 feet, 6 inches to the *property line*; and
 - (C) There shall be a minimum 6-foot, 8-inch clearance between *proposed grade* and the projection.
 - (D) A roof design element may project into the space above the required angled *building envelope* plane, as depicted in Diagram 131-04S, provided that the roof design element:
 - (i) Faces the front *yard*;
 - (ii) Does not encroach into any required *yard*;
 - (iii) Complies with all applicable *structure height* limits in accordance with Section 113.0270; and
 - (iv) Is limited to a maximum of 33 percent of the width of the *building envelope* facing the front *yard*, and a maximum depth equal to or less than its width.

Diagram 131-04S

Exception for Angled Building Envelope Area

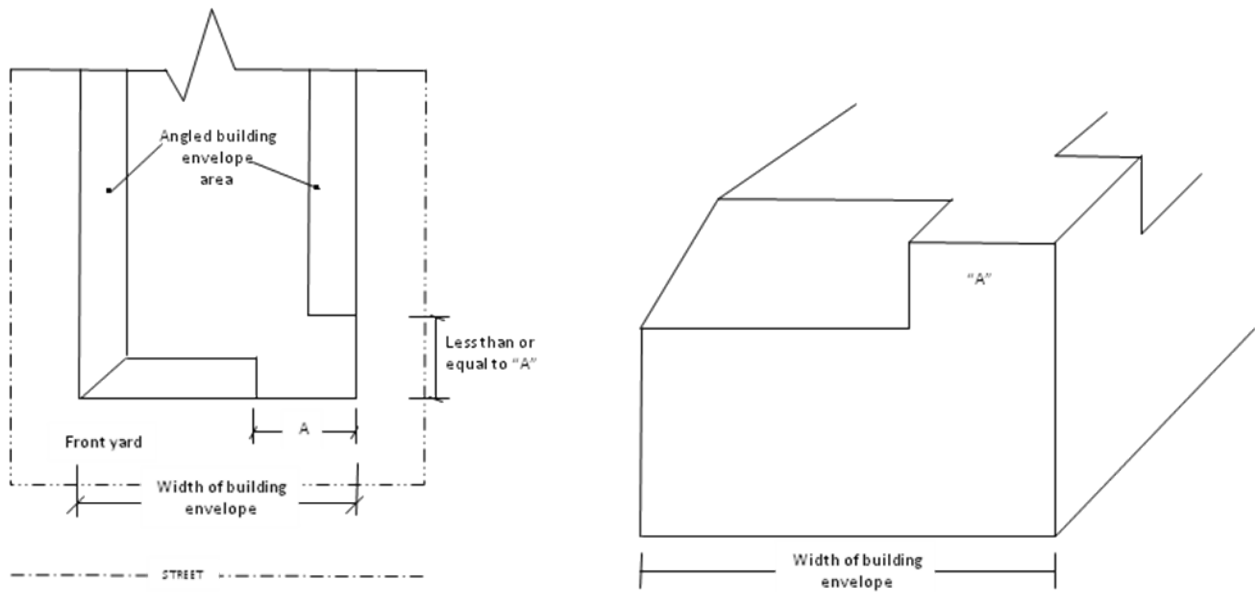

Note: "A" shall not exceed 33% of the width of the building envelope

- (2) Openly supported *architectural projections*, including trellises, may encroach into required *yards*, as shown in Diagram 131-04T, subject to the following:
- (A) The height shall not exceed the height of the *roof eave* or the sill plate of the second *floor*, whichever is lower;
 - (B) The projection shall be at least 50 percent open in plan view;
 - (C) The projection may extend a maximum of 6 feet into the required *yard* or 50 percent of the width of the required *yard*, whichever is less;
 - (D) The projection shall not be closer than 2 feet, 6 inches to the *property line*;
 - (E) There shall be a minimum 6-foot, 8-inch clearance between *proposed grade* and the lowest horizontal portion of the projection, not including the supports, as described in Section 131.0461(a)(2)(F), below; and
 - (F) Diagonal supports from the building wall, such as knee braces, extending within a 45-degree angle from the building wall to the horizontal portion of the projection are permitted, provided that the horizontal and vertical components of the supports do not exceed 3 feet. There shall be a minimum spacing of 6 feet between supports.

Diagram 131-04T

Openly Supported Architectural Projections

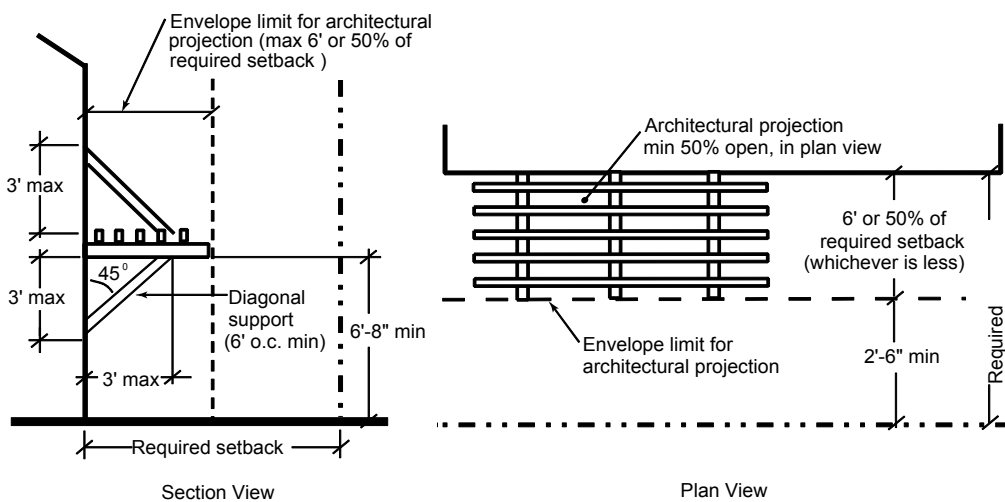

- (3) Bay windows may project into required *yards*, as shown in Diagram 131-04U, subject to the following requirements:
 - (A) There shall be a minimum 1-foot clearance between the lowest point of the bay window *structure* and *proposed grade* directly below;
 - (B) The bay window shall not project into the required *yard* more than 4 feet or 50 percent of the width of the required *yard*, whichever is less. The bay window shall not be closer than 3 feet to the *property line*;
 - (C) The bay window shall not be more than 8 feet in width;
 - (D) The bay window may extend to the maximum permitted height of the *building envelope*; and
 - (E) There shall be a 16-foot or greater spacing between bay windows, and no more than two bay windows per elevation shall encroach into the required *yard*.

Diagram 131-04U

Bay Window Yard Projections

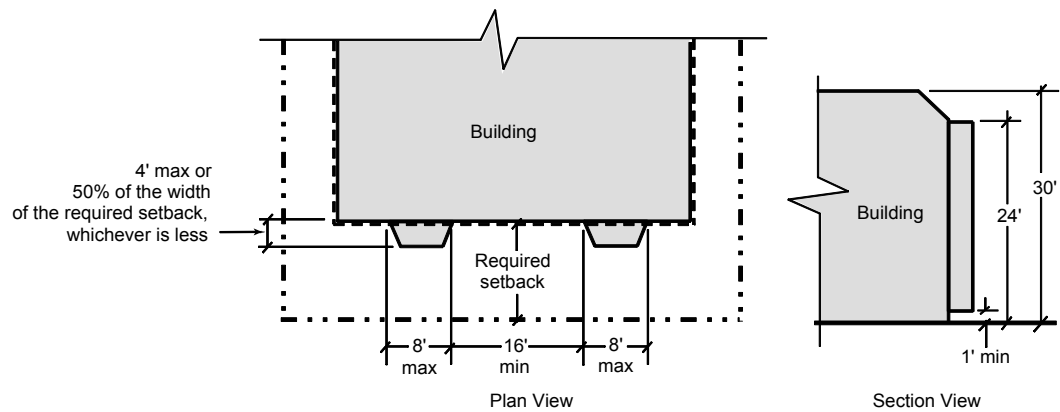

- (4) Fireplace enclosures may encroach into required *yards* and the angled *building envelope* plane subject to the following requirements:
 - (A) The fireplace enclosure may not encroach into the required *yard* more than 2 feet, 6 inches or 50 percent of the width of the required *yard*, whichever is less. The fireplace shall not be closer than 2 feet, 6 inches to the *property line*;

- (B) The fireplace and chimney are not subject to the 45-degree sloped *building envelope* requirement and may extend to the maximum *structure height* at the required *setback*;
 - (C) The fireplace enclosure shall have a maximum width of 10 feet measured from *grade* to the *roof eave* or the sill plate of the second *floor*, whichever is lower, and a maximum width of 5 feet beyond that; and
 - (D) No more than two projecting fireplaces per building elevation are permitted.
- (5) Mechanical equipment such as air conditioner units, gas meters, electrical fuse boxes, or pool equipment and associated utility enclosures may encroach into required side and rear *yards* subject to the following requirements:
- (A) At-grade equipment shall be located a minimum of 4 feet from the *property line*; and
 - (B) Equipment that is located completely below finished grade, with a permanent, durable, protective cover shall be permitted to encroach up to 2 feet, 6 inches from the *property line*;
 - (C) Except that no *setback* shall be required for air conditioner units within a side or rear *yard* where sound attenuation features are incorporated and demonstrated to comply with applicable sound level limits in accordance with Section 59.5.0401.
- (6) Entry roofs and porches may encroach into the required front and *street* side *yards* subject to the following requirements:
- (A) The *encroachment* shall not exceed 6 feet or 50 percent of the width of the required *yard*, whichever is less;
 - (B) The height of the entry roof shall not exceed 15 feet above *grade*;
 - (C) The width of the *encroachment* shall not exceed 10 feet or 50 percent of the width of the habitable portion of the building elevation, whichever is greater; and
 - (D) Porches shall be maintained with at least two elevations that are at least 40 percent open.

- (7) Entry arbors may encroach into required front and *street* side yards, as shown in Diagram 131-04V, subject to the following requirements
 - (A) The height of the arbor shall not exceed 10 feet for flat-topped *structures* or 12 feet for sloping *structures*;
 - (B) The width of the arbor shall not exceed 6 feet, measured to the centerlines of the supports. A maximum 2-foot overhang is permitted on each side of the center of the supports, as long as the overhang does not project into the *public right-of-way*;
 - (C) The horizontal surface of the arbor, including overhang, must provide a minimum 6-foot, 8-inch clearance above *proposed grade*;
 - (D) Supports shall not exceed a maximum dimension of 12 inches by 12 inches;
 - (E) There shall be at least 6 feet between supports along the length of the arbor;
 - (F) In plan view, the arbor shall be at least 40 percent open. Fencing between posts is subject to Chapter 14, Article 2, Division 3 (Fence Regulations);
 - (G) The arbor shall not be enclosed on any side other than the side attached to the building, if attached; and
 - (H) Arbors may encroach the entire width of the required *yard* but may not project beyond the *property line*.

Diagram 131-04V
Entry Arbor Yard Projections

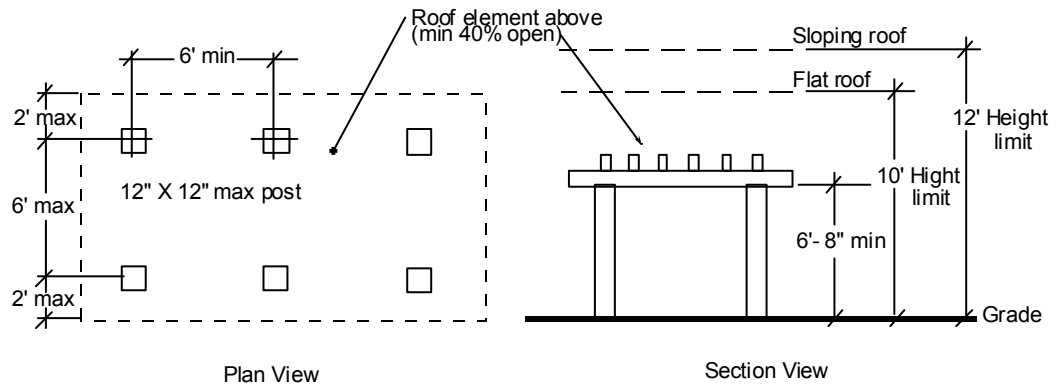

- (8) *Patio structures* may be located within a required side *yard* or rear *yard*, subject to the following requirements:
- (A) The *patio structure* shall not be located closer than 5 feet to any *property line*;
 - (B) The *patio* shall be open on at least three sides except for support columns with maximum dimensions of 18 inches by 18 inches in plan view;
 - (C) The support columns shall have a minimum separation of 8 feet measured on center; and
 - (D) The height of the roof of the *patio* shall not exceed the *roof eave* or the sill plate of the second *floor*, whichever is lower.
- (9) *Dormers* are permitted to encroach into required *yards* and into the angled *building envelope* plane subject to the following:
- (A) The total length of all *dormers* on a building wall may not exceed 30 percent of the total length of the building along that wall;
 - (B) A *dormer* may not exceed 10 feet in width, measured at the building wall;

- (C) There shall be a minimum of 4 feet between each *dormer*, including eaves;
- (D) Projecting *dormers* may project through the 30/45-degree sloped *building envelope* plane and may encroach 4 feet into the required *yard* or 50 percent of the width of the adjacent required *yard*, whichever is less; provided, however, that the *dormer* may not be closer than 3 feet to the *property line*; and
- (E) A *dormer* may be a vertical extension of a bay window.

Diagram 131-04W
Dormer Projection into Angled Building Envelope Plane

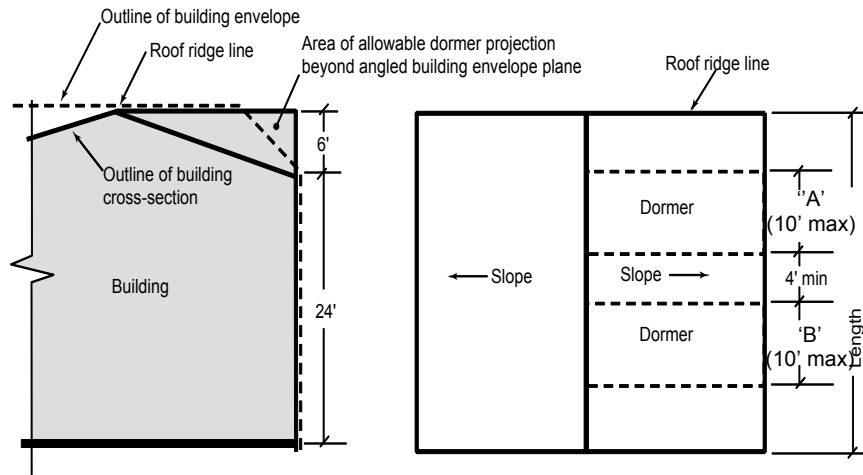

NOTE: Total width of dormer projections ('A' + 'B') shall not exceed 30% of length of roof plan in RM -1-1, RM -1-2, RM -1-3 zones or 50% of length of roof plan in RM -2-4, RM -2-5, RM -2-6 zones.

Section

Roof Plan

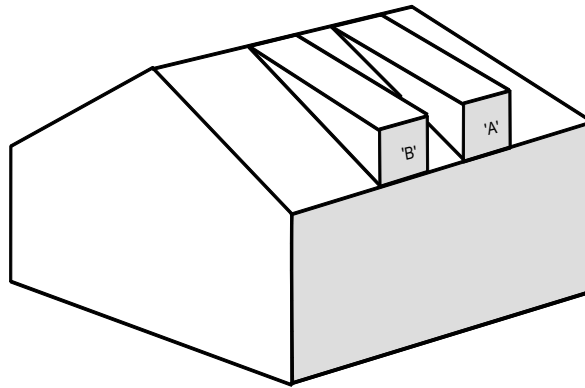

3-Dimension

- (10) Unroofed *structures*: An unroofed portion of a *structure* not in excess of 3 feet above *proposed grade*, with an open safety railing not exceeding 42 inches in height, is permitted within a required side or rear *yard*.
- (11) Swimming pools, spas, and hot tubs are permitted within a required *yard* subject to the following:
 - (A) Swimming pools that project 3 feet or less above grade may be located a minimum of 3 feet from the *property line*.
 - (B) Swimming pools that project greater than 3 feet above grade are not permitted to encroach within a required *street yard* or interior side *yard setback*, but may encroach into the rear *yard* setback if located a minimum of 4 feet from the rear *property line*.
- (12) Garages or non-habitable *accessory buildings* may encroach into a required side or rear *yard* as follows:
 - (A) The *lot* size shall not exceed 10,000 square feet;
 - (B) The encroaching *accessory building* shall be limited to a maximum *structure height* of 15 feet within the *setback*;
 - (C) The encroaching *accessory building* shall not share a common wall with the primary *dwelling unit*, but may be attached via a non-structural design element. Any *development* attached to the *accessory building* above one *story* shall comply with the *setback*;
 - (D) The *accessory building* shall not exceed a maximum length of 30 feet within any given *setback*; and
 - (E) An encroaching *accessory building* shall not exceed 525 square feet in *gross floor area*.
- (b) The following are permitted *architectural projections* and *encroachments* into the required front and street side *yard* for the RT zones. A maximum of 50 percent of the area of the required minimum front *yard* (the front 5 feet of the *lot*) may be used for *encroachments*. See Section 131.0464(c) for required building articulation features. No permitted projection or *encroachment* may be located in a required *visibility area* or a required turning radius or vehicle back-up area except where development regulations may allow.

- (1) Projecting balconies may encroach into required minimum front and street side *yards* subject to the following requirements:
 - (A) One unenclosed projecting balcony is permitted for each *story* above the first *story*;
 - (B) A projecting balcony may encroach up to 4 feet into required minimum *yards*;
 - (C) Support posts to the ground below are not permitted unless the area below the balcony serves as a projecting entry and provides shelter for an access door to the dwelling unit; and
 - (D) The maximum permitted width of projecting balconies is 8 feet.
- (2) Bay windows may encroach into required minimum front and street side *yards* subject to the following requirements:
 - (A) Bay windows are limited to two per *story*;
 - (B) The maximum permitted width of bay windows is 8 feet;
 - (C) Bay windows may encroach a up to 4 feet into required minimum *yards*; and
 - (D) Bay windows may extend to the height of the building or there may be a horizontal separation between the bay windows.
- (3) Turrets with or without cupola may encroach into the required minimum front and street side *yards* and may extend into the sloped *building envelope* area subject to the following requirements:
 - (A) Only one turret per *lot* may be used;
 - (B) A turret located at the corner of the building on a corner *lot* may encroach into both the front and street side *yards*;
 - (C) A turret may encroach up to 4 feet into required *yards*; and
 - (D) A turret (and cupola) may also extend above the building height limit and into the sloped *building envelope* area so that the highest point is up to 5 feet above the maximum *structure height* of the base zone. However, no *structure* or addition to a *structure* shall be permitted to exceed the established height limit of any overlay zone. (See Overlay Zones Chapter 13, Article 2, Division 1.)
- (4) Projecting entries, either at *grade* or elevated with accompanying stairs and cover, may encroach into required minimum front and street side *yards* subject to the following requirements:
 - (A) Only one entry per elevation is permitted;

- (B) The height of the *floor* of an elevated entry shall not exceed 42 inches above *proposed grade*;
 - (C) The entry may not be closer than 4 feet to the front *property line*; and
 - (D) The width of a projecting entry shall not exceed 50 percent of the width of the *building facade*.
- (5) Trellis projections and eaves may project into required minimum front and street side yards subject to the following requirements:
- (A) Trellises may project into required minimum *yards* up to the *property line*, but no portion of the trellis may extend beyond the *property line*;
 - (B) Eaves may project 2 feet, 6 inches into the required minimum *yards*; and
 - (C) There shall be at least 6 feet, 8 inches of clearance between *proposed grade* and the bottom of the projections.
- (6) *Dormers* may project into required minimum front and street side *yards* subject to the following requirements:
- (A) A maximum of two *dormers* are permitted per elevation;
 - (B) The maximum width of *dormers* shall be 10 feet; and
 - (C) *Dormers* may extend into the sloped *building envelope* area.
- (7) A detached garage may encroach into the street side *yard* subject to the following requirements:
- (A) The garage may not exceed 12 feet in height; and
 - (B) The garage must be located within the rear 30 feet of the *lot*.
- (c) In the RM-2-4, RM-2-5, RM-2-6, RM-3-7, RM-3-8, RM-3-9, RM-4-10, RM-4-11, and RM-5-12 zones, *architectural projections* and *encroachments* listed in Section 131.0461(a) are permitted with the following limitations. No permitted *architectural projection* or *encroachment* may be located in required *yards* within view corridors that are designated by *land use plans* in the Coastal Overlay Zone, in a required *visibility area*, a required turning radius, or vehicle back-up area except where *development* regulations may allow.

- (1) For front and rear *yards*, one *encroachment* is permitted per 50 feet of *building facade* length, with a minimum of 10 feet between *encroachments*.
- (2) For side *yards*, two *encroachments* are permitted per 50 feet of *building facade* length, with a minimum of 10 feet between *encroachments*.
- (3) A minimum of 3 feet must be provided between the *encroachment* and the *property line*.
- (4) Garages or non-habitable *accessory buildings* that meet the requirements in Sections 131.0461(a)(12)(A) through 131.0461(a)(12)(E) may only encroach into a required side or rear *yard* if they are detached.
- (5) *Dormers* may project into the angled *building envelope* plane as follows:
 - (A) The aggregate width of *dormers* may not exceed 50 percent of the length of the roof plan to which the *dormers* will be attached; and
 - (B) *Dormers* may not extend beyond a height of 40 feet.

(Amended 6-12-2001 by O-18948 N.S.; effective 12-12-2001.)

(Amended 11-28-2005 by O-19444 N.S.; effective 2-9-2006.)

(Amended 11-13-2008 by O-19801 N.S.; effective 12-13-2008.)

(Amended 8-4-2011 by O-20081 N.S.; effective 10-6-2011.)

(Amended 6-18-2013 by O-20261 N.S.; effective 7-19-2013.)

(Amended 5-5-2015 by O-20481 and O-20483 N.S.; effective 6-4-2015)

§131.0462 Requirements for Attached Units in the RX Zones

The street wall of an attached dwelling unit shall be horizontally offset a minimum of 4 feet from the street wall of the dwelling unit to which it is attached.
(Added 12-9-1997 by O-18451 N.S.; effective 1-1-2000.)

§131.0463 Roof Design Variation Requirements in the RX Zones

In the RX zones, for *developments* exceeding 8 dwelling units, at least 30 percent of the units shall have roof designs that vary from the remainder of the dwelling units.
(Added 12-9-1997 by O-18451 N.S.; effective 1-1-2000.)

§131.0464 Supplemental Requirements for Residential Zones

- (a) Supplemental Requirements for RE and RS Zones
 - (1) *Manufactured homes* are permitted as residential dwelling units subject to all regulations of the applicable zone in addition to the following supplemental regulations:
 - (A) Siding shall be of nonreflective material such as wood, vinyl, stucco, decorative stone, or masonry;
 - (B) Roofing materials shall be of nonreflective material such as concrete tiles, fiberglass shingles, or composition shingles, shakes, or tiles;
 - (C) Eaves shall be between 12 and 16 inches measured from the vertical side of the exterior wall; and
 - (D) The foundation along the exterior perimeter shall conform to the Building Regulations and shall consist of poured concrete, masonry, or approved all-weather material. If the foundation material is not masonry or concrete, it shall match the siding material of the home.
- (b) Supplemental Requirements for RX Zones:
 - (1) For *lots* without *alley* access, a minimum of 25 percent of the length of the *building facade* on the ground *floor* must be utilized for habitable space.
 - (2) *Manufactured homes* are permitted as residential dwelling units provided they comply with the regulations in Section 131.0464(a)(1).
- (c) Supplemental Requirements for RT Zones:
 - (1) When an RT *development* exceeds 12 units and the *lots* are greater than 90 feet in depth, the front facade of one-third of the dwelling units must be offset 3 feet from the front facade of the remaining units.

- (2) For all dwelling units, 20 percent of the area of the front facade shall be used for door and window areas.
- (3) One building articulation feature from each category listed below shall be incorporated into each dwelling unit:

Category A:

Elevated first *floor*
Projecting balcony
Bay windows (2)

Category B:

Turret (with or without cupola)
Inset balcony
Angled side planes (2)
Projecting (or inset) elevated entry

Category C

Planter boxes
Trellises
Inset windows
Projecting covered entry

Dormers

Inset entry

Building articulation features shall be provided in accordance with the following regulations. Those features that may project into the required front and street side yards are indicated and are subject to the requirements in Section 131.0461(c).

- (A) *Elevated First Floor.* The elevation of the ground *story* (first *floor*) shall be 42 inches above *proposed grade*.
- (B) *Projecting Balcony.* A maximum of one projecting balcony is permitted for each *story* above the first *story*. Each balcony may be roofed or unroofed. Open or solid safety railings not to exceed 42 inches in height are permitted. (See Section 131.0461(b)(1) for *yard encroachment* regulations).
- (C) *Bay Windows.* At least two bay windows per elevation are required. A minimum of 40 percent of each bay window elevation shall be glass. (See Section 131.0461(b)(2) for *yard encroachment* regulations).

- (D) Turret. The minimum size of a turret shall be 6 feet by 6 feet or shall have a 6-foot diameter in plan dimensions. Turrets shall extend from the ground (first *story*) level for the full height of the building or shall extend from the second *story* to the full height of the building. A turret may project into the space above the angled *building envelope* plane to 5 feet above the maximum permitted *structure height*.

For each *story*, at least 40 percent of the turret elevation shall be glass. At the first *story*, an entry door may substitute for an equal square footage amount of glass area. Only one bay window per *story* may be used if a turret is provided. (See Section 141.0461(b)(3) for *yard encroachment* regulations).

- (E) Inset Balcony. A maximum of two inset balconies are permitted per elevation. Each balcony may be roofed or unroofed. Open or solid safety railings not to exceed 42 inches in height are permitted.
- (F) Angled Side Planes. At both side *setbacks*, the *structure* shall observe 60-degree planes sloping inward above 25 feet in height to the maximum permitted building height. At minimum, angled planes must be located on the front 50 percent of the *structure*. *Dormers* may project from the angled side planes to the side *property lines* but may not be closer than 3 feet to a *street side property line*.
- (G) Projecting Elevated Entry. One projecting entry is permitted per elevation. The entry must be unenclosed on three sides and may have a maximum 42-inch-high open safety railing. The entry shall be a minimum of 6 feet and a maximum of 8 feet wide. The entry may have an unenclosed balcony with the same horizontal dimensions above it. Stairs providing access to the entry for buildings with an elevated first *floor* shall not be included in the determination of width. (See Section 131.0461(b)(4) for *yard encroachment* regulations).
- (H) Planter Boxes. Planter boxes shall be of wood, brick, stone, or finished/patterned concrete construction. The minimum total area of the planter boxes shall be 40 square feet. The walls of the planter boxes shall be at least 24 inches and no more than 36 inches high. The planter boxes shall be located adjacent to the *structure*, entry, walkway, or *property line*. Wrought iron fencing (and gate), at least 50 percent open, may be placed in the required front *yard* either separately or in conjunction with the planter boxes, in accordance with the *fence* height regulations in Chapter 14, Article 2, Division 3 (*Fence Regulations*).

- (I) Trellises. Trellises shall be at least 50 percent open in plan view. Diagonal supports from the building wall extending within a 45-degree angle from the building wall to the horizontal portion of the projection are permitted. (See Section 131.0461(b)(5) for *yard encroachment* regulations).
 - (J) Inset Windows. A maximum of two inset windows are permitted per *story*. The window surface must be set back at least 6 inches from the front facade.
 - (K) Projecting Covered Entry. One projecting covered entry is permitted per elevation. The entry shall be at least 6 feet but no more than 8 feet wide. The required cover shall be no more than 50 percent open. The entry may have an unenclosed balcony with the same horizontal dimensions, above it. (See Section 131.0461(b)(4) for *yard encroachment* regulations).
 - (L) *Dormers*. *Dormers* may project into the space above the angled *building envelope* plane. *Dormers* may have pitched or curved roofs. The maximum width for *dormers* is 5 feet. At the side and *street* side *setbacks* a minimum separation of 10 feet between *dormers* is required. (See Section 131.0461(b)(6) for *yard encroachment* regulations).
 - (M) Inset Entry. One inset entry is permitted per elevation. Inset entries shall be either at *grade* or elevated. The entry must be set back at least 24 inches from the facade and may have a maximum 42-inch-high open safety railing.
- (d) Supplemental Requirements for RM-1-1, RM-1-2, RM-1-3 Zones
- (1) For *lots* with a width of 60 feet or less, not more than two 10-foot-wide garage doors or garage entries or a single 16-foot-wide garage door or entry on the *building facade* is permitted, except when that door accesses underground parking. For each additional 25 feet of *street frontage*, an additional 10 feet maximum width garage door or garage entry is permitted.
 - (2) For *lots* with a width of 50 feet or less, at least 40 percent of the length of the *building facade* on the ground *floor* must enclose habitable area (not garage or parking entrance); for *lots* greater than 50 feet in width, at least 50 percent of the length of the *building facade* on the ground *floor* must enclose habitable area. See Diagram 131-04X.

Diagram 131-04X
Ground Floor Habitable Space Requirement

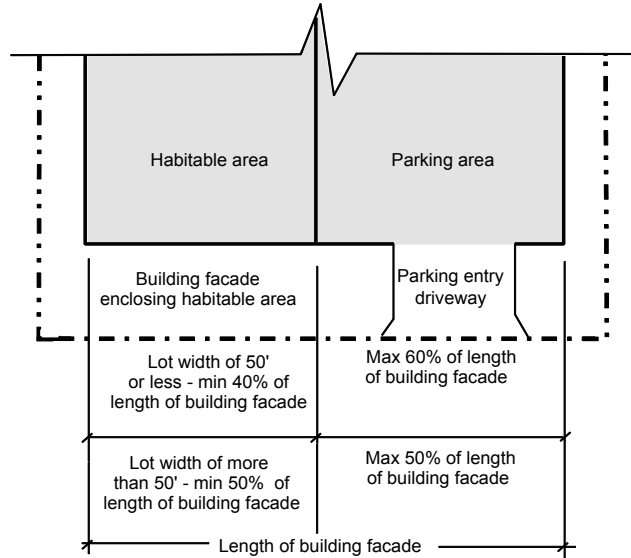

- (3) Within the front facade on all *floors* above the first *floor*, a transparent glass window or windows with an aggregate area of at least 20 square feet shall be provided for each dwelling unit that faces the *street*.

- (e) Supplemental Requirements for the RM-2-4, RM-2-5, RM-2-6 Zones
 - (1) For *lots* with a width of 60 feet or less, not more than two 10-foot-wide garage doors or garage entries or a single 16-foot-wide garage door or entry on the *building facade* is permitted, except when that door accesses underground parking. For each additional 25 feet of *street frontage*, an additional 10 feet maximum width garage door or garage entry is permitted.
 - (2) Garages, carports, and other parking entries in the *building facade* shall be set back at least an additional 5 feet from the facade wall enclosing habitable space, as shown in Diagram 131-04Y.
 - (3) For *lots* with a width of 50 feet or less, at least 40 percent of the length of the *building facade* on the ground *floor* must enclose habitable area (not a garage or parking entrance); for *lots* greater than 50 feet in width, at least 50 percent of the length of the *building facade* on the ground *floor* must enclose habitable area. See Diagram 131-04Y.

Diagram 131-04Y

Parking Area/ Habitable Space Offset

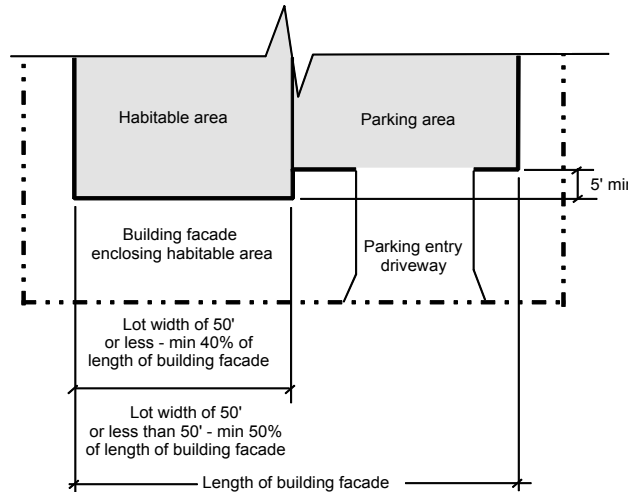

- (4) Within the *building facade* on all *floors* above the first *floor*, a transparent glass window or windows with an aggregate area of at least 20 square feet shall be provided for each dwelling unit that faces the *street*.

(f) Supplemental Requirements for the RM-3-7, RM-3-8, RM-3-9 Zones

When the ground *floor* of a building is used for parking and the parking is adjacent to a required *yard*, the parking area must be *screened* by a minimum 6-foot-high *fence* or 6-foot-high landscaping. A pedestrian entry to the building from each *street* must be provided.

(Added 12-9-1997 by O-18451 N.S.; effective 1-1-2000.)

(Amended 11-28-2005 by O-19444 N.S.; effective 2-9-2006.)

§131.0466 Deviations from Development Regulations for Reasonable Accommodations

The Federal Fair Housing Act and the California Fair Employment and Housing Act require that jurisdictions make *reasonable accommodations* to afford *disabled persons* the equal opportunity to use and enjoy a dwelling. In consideration of the special need and the potential benefit that can be accomplished with a requested modification, deviations may be approved through Process One subject to the following:

- (a) The *development* will be used by a *disabled person*;
- (b) The deviation request is necessary to make specific housing available to a *disabled person* and complies with all applicable development regulations to the maximum extent feasible;
- (c) The deviation request will not impose an undue financial or administrative burden on the City;
- (d) The deviation request will not create a fundamental alteration in the implementation of the City's zoning regulations.
- (e) For *coastal development* in the *coastal overlay zone*, that is not exempt pursuant to Section 126.0704, there is no feasible alternative that provides greater consistency with the certified Local Coastal Program.

(Added 11-28-2005 by O-19444 N.S.; effective 2-9-2006.)

(Amended 11-13-08 by O-19803 N.S.; effective 12-13-2008.)